





JULIBAO-R9000 SX H2300



-  **25%**
Output
-  **5**
Repeats
-  **43**
cm/Repeats

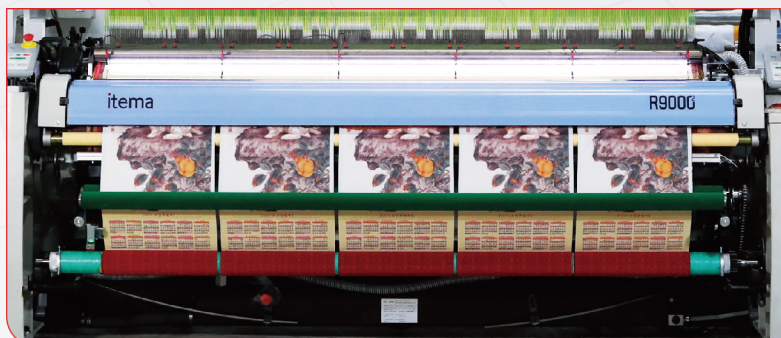

- 5 repeats with higher productivity, wider width.
- Excellent full width Temple support, to ensure that both sides of the fabric maintain the same weaving effect even with more wider machine.

• JACQUARD OPTION



STAUBLI SX PRO
 HOOKS:UP TP 2688
 CONTROLLER:TC8
 ORIGINAL FRANCE MADE,ADVANCED STAUBLI JACQUARD

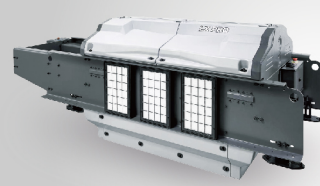

STAUBLI LX PRO
 HOOKS:UP TO 7680
 CONTROLLER:TC8
 ASSEMBLY IN HANGZHOU,ECONOMICAL STAUBLI JACQUARD



BONAS JI
 HOOKS:UP TO 11520
 CONTROLLER:CI
 THE LATEST MICRO-SELECTOR SYSTEM,REDUCED THE JACQUARD SIZE



CHANGFANG JL1620
 HOOKS:UP TO 2688
 CONTROLLER:CFJC320
 ECONOMICAL PRICE OF CHINESE JACQUARD

• LOOM FEATURES

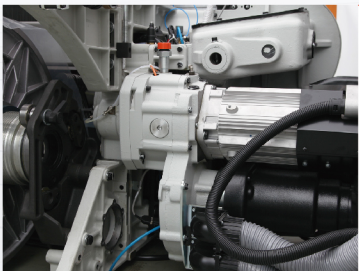

ENERGY SAVING
 The optimization of the machine main mechanical components and lubrication system allows a considerable energy consumption reduction.



SK RAPIER
 The SK transfer system is engineered for high speed and versatility and provides consistent performance and reduced wear.The insertion rapier is positioned very close to the reed promoting increased efficiency and dependable quality.



LOOM OPTION
 Using ITEMA weaving loom as our base loom,which is the advanced loom manufacturer for jacquard fabric.Multiple choices for loom,IteMa R9500 (Italy original),IteMa R9000 H1900 and ITEMA R9000 H2300(ITEMA SHANGHAI)



WEFT YARN SELECTORS
 weft yarn are not all the same Efficient weaving of high-quality fabrics ,also with complex and mixed types of yarns, is made possible by the IteMa weft selectors, available for 8-12 colors and featuring two different size of the finger eyelet.



MULTIPLE CHOICE FOR WEFT CUTTERS:

- Mechanical Weft Cutter: Reliable and effective also in the most demanding weaving conditions;
- Motorized Weft Cutter: Ideal solution when weaving complex styles and/or multiple weft configurations, providing unbeatable versatility and textile efficiency.



LATEST GENERATION TOUCH-SCREEN CONSOLE
 The IteMa Electronic NCP – New Common Platform – comes here loaded on a high-performance, super sensitive touch-screen console.



• LABELING SYSTEM FEATURES



CUTTING SYSTEM

Latest developed JLB-TCS thermal cutting system. precisely monitor the fabric moving speed and auto adjust the cutter temperature, achieve soft edge cut quality.

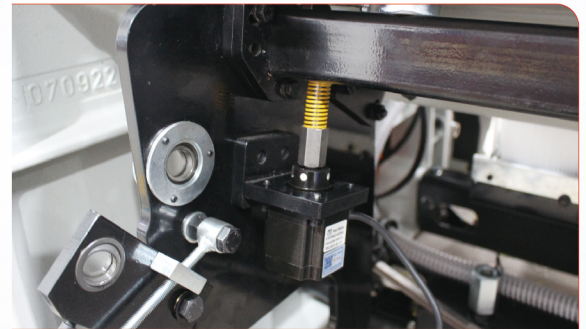

IRONING PLATE LIFTING SYSTEM

Can choose Digital Motor as the lifting system for ironing plate, achieve precise control of the lifting space, 0.05mm lifting accuracy, combine with spring to achieve the most excellent and accurate ironing effect.

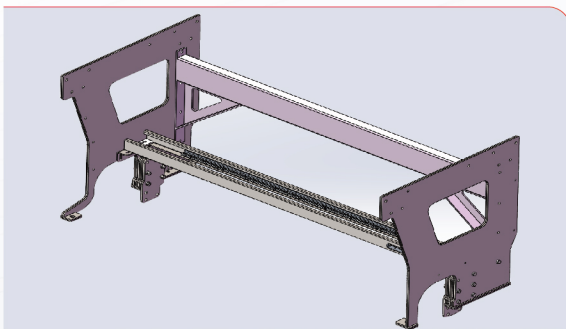

GANTRY

Excellent machine jacquard frame wall panel design, the use of double-layer high strength steel plate, suitable for high-speed operation, small vibration, stable structure.



FULL WIDTH TEMPLE

Specialized full width temple, easily to weave the highest density label, no banana effect of the edge side labels. Inside thermal bar can give less shrinkage of two edge.



HARNESS KIT

- RTS harness Cord (Italy)
- Hornex Harness Board (Germany)
- Atem Heddle (Italy)

Ensure a longer a use life of the harness kit, suitable for higher density weaving, fine yarns and less black on the white labels.



WEFT FEEDER-IRO STAR G2/LASER G2

The latest feeder developments into one neat package. Making use of a new and improved mechanical sensor system, and using our permanent magnet motor technology, ensures perfect speed regulation with dramatically reduced power consumption. The user-friendly design ensures easy handling and operation. Star G2 as standard, Laser G2 as option.



• CONFIGURATION PARAMETER

Loom		
Model	Itema R9500	H1900
	Itema R9000	H1900
	Itema R9000	H2300
Weft Selector	8	Standard
	12	Optional
Weft Cutter	Mechanical	(R9000 Standard)
	Electronic	(R9500 Standard) (R9000 Optional)
Weft Transfer System	SK Rapier	Guide Hook
Fabric Width	160CM-180CM	H1900
	200CM-220CM	H2300
Take Up	Electronic	Standard
Send Off	Electronic warp let-off motion with tensioning device	Standard
Electron Density	Electronic density adjustment from 5-150 picks/cm	Standard
Warp Beam	Single Warp Beam	Diameter 800mm
JACQUARD		
Model	Staubli Sxpro	Up To 2688
	Staubli Lxpro	Up To 7680
	Staubli Lxl Pro	Up To 11520
	Bonas Ji2	Up To 2688
	Bonas Ji5	Up To 5760
	Bonas Jil	Up To 11520
	Changfang JI1620	Up To 6144
WEAVING PARAMETER		
2304/2400/2496 Hooks	4 Repeats	Taffeta
	8 Repeats	Satin
4608/4800/4992 Hooks	2 repeats	Taffeta
	4 Repeats	Satin
9216/9600/9984 Hooks	1 Repeat	Taffeta
	2 Repeats	Satin
LABELING SYSTEM		
Ironing Lift Up System	Cylinder	Standard
	Digital Motor	Optional
Cutting System	JLB-TCS Thermal Cutting System	Standard
	8mm Cutter	Standard
	6mm Cutter	Optional
HARNESS KIT		
Harness Cord	Italy Rts	Standard
Harness Board	Germany Hornex	Standard
Heald	Korea Hyundai	Standard
	Italy Atem	Optional
WEFT FEEDER		
Model	Iro Star G2	Standard
	Iro Laser G2	Optional
OTHER SPECIFICATION		
Power Supply	3 phase, 380V/50HZ	Standard
	220V/60hz	Optional
Dimension	W5300mm*L2200mm*H4050mm	H1900
	W5700mm*L2200mm*H4200mm	H2300
Weight	Approx 6500kg	