



RICAMBI PER TELAI
SPARE PARTS FOR LOOMS

t e c h n i c a l d a t a



INDICE
INDEX

Ricambi intercambiabili con gli originali	VAMATEX	da pagina 02 a pagina 10
Ricambi intercambiabili con gli originali	SOMET	da pagina 11 a pagina 20
Ricambi intercambiabili con gli originali	N. PIGNONE	da pagina 21 a pagina 25
Ricambi intercambiabili con gli originali	PICANOL	da pagina 26 a pagina 33
Ricambi intercambiabili con gli originali	SULZER RÜTI	da pagina 34 a pagina 37
Ricambi intercambiabili con gli originali	DORNIER	da pagina 38 a pagina 40
Ricambi intercambiabili con gli originali	PANTER	da pagina 41 a pagina 43
Ricambi intercambiabili con gli originali	ZELLWEGER	da pagina 44 a pagina 44
Ricambi intercambiabili con gli originali	VAN DE WIELE	da pagina 45 a pagina 45
Ricambi intercambiabili con gli originali	VARI MODELLI	da pagina 46 a pagina 51

<i>Spare parts interchangeable with the originals</i>	VAMATEX	<i>from page 02 to page 10</i>
<i>Spare parts interchangeable with the originals</i>	SOMET	<i>from page 11 to page 20</i>
<i>Spare parts interchangeable with the originals</i>	N. PIGNONE	<i>from page 21 to page 25</i>
<i>Spare parts interchangeable with the originals</i>	PICANOL	<i>from page 26 to page 33</i>
<i>Spare parts interchangeable with the originals</i>	SULZER RÜTI	<i>from page 34 to page 37</i>
<i>Spare parts interchangeable with the originals</i>	DORNIER	<i>from page 38 to page 40</i>
<i>Spare parts interchangeable with the originals</i>	PANTER	<i>from page 41 to page 43</i>
<i>Spare parts interchangeable with the originals</i>	ZELLWEGER	<i>from page 44 to page 44</i>
<i>Spare parts interchangeable with the originals</i>	VAN DE WIELE	<i>from page 45 to page 45</i>
<i>Spare parts interchangeable with the originals</i>	OTHER MODELS	<i>from page 46 to page 51</i>

Nell'intento di migliorare costantemente la qualità della sua produzione, la FIBERCOMPOSITI si riserva il diritto di modificare, senza preavviso, le caratteristiche tecniche menzionate nel suo catalogo, che non hanno quindi carattere impegnativo.

Nel presente catalogo sono rappresentati solo alcuni dei prodotti disponibili. Per ulteriori informazioni rivolgersi ai numeri:

Tel. 034663248 Fax 034663390 oppure fiber@fibercompositi.it, www.fibercompositi.it









In order to constantly improve the quality of its production FIBERCOMPOSITI reserves the rights to modify the characteristics mentioned in its catalogue without prior notice. This catalogue contains only some of the available products for further information or specific requests contact:

Ph. +39 034663248 Fax +39 034663390 or fiber@fibercompositi.it www.fibercompositi.it

NASTRI PER TELAI VAMATEX INTERCAMBIABILI CON GLI ORIGINALI RAPIER TAPES FOR VAMATEX LOOMS INTERCHANGEABLE WITH THE ORIGINALS

MODELLO LEONARDO K2000 PORTANTE MODEL LEONARDO K2000 BRINGER

**MATERIE PRIME
RAW MATERIALS**





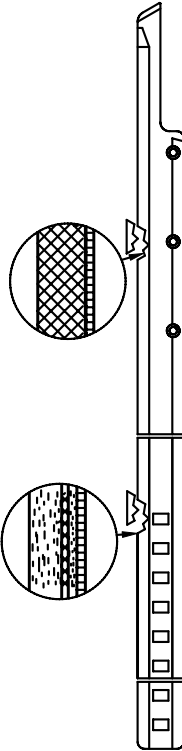



 TEFLON,  CARBONIO
 TEFLON,  CARBON FIBER,  POLIESTERE,
 TEFLON,  CARBON FIBER,  POLYESTER,

ALT. TELAIO LOOM WIDTH	LUNG. NASTRO TAPE LENGTH	Fibercompositi CODICE/ CODE	VARIANTE/ VARIANT	
			C	S
H. 1700 mm.	2230 mm.	11072230P		
H. 1900 mm.	2330 mm.	11072330P		
H. 2100 mm.	2430 mm.	11072430P		
H. 2200 mm.	2480 mm.	11072480P		
H. 2300 mm.	2530 mm.	11072530P		
H. 2600 mm.	2680 mm.	11072680P		
H. 2800 mm.	2780 mm.	11072780P		
H. 3000 mm.	2910 mm.	11072910P		
H. 3200 mm.	3010 mm.	11073010P		
H. 3400 mm.	3110mm.	11073110P		
H. 3600 mm.	3210 mm.	11073210P		
H. 3800 mm.	3310 mm.	11073310P		



MODELLO LEONARDO K2000 TRAENTE MODEL LEONARDO K2000 TAKER

**MATERIE PRIME
RAW MATERIALS**





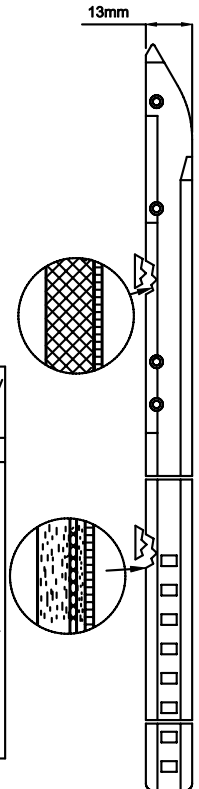



 TEFLON,  CARBONIO
 TEFLON,  CARBON FIBER,  POLIESTERE,
 TEFLON,  CARBON FIBER,  POLYESTER,

ALT. TELAIO LOOM WIDTH	LUNG. NASTRO TAPE LENGTH	Fibercompositi CODICE/ CODE	VARIANTE/ VARIANT	
			C	S
H. 1700 mm.	2140 mm.	11072140T		
H. 1900 mm.	2240 mm.	11072240T		
H. 2100 mm.	2340 mm.	11072340T		
H. 2200 mm.	2390 mm.	11072390T		
H. 2300 mm.	2440 mm.	11072440T		
H. 2600 mm.	2590 mm.	11072590T		
H. 2800 mm.	2690 mm.	11072690T		
H. 3000 mm.	2820 mm.	11072820T		
H. 3200 mm.	2920 mm.	11072920T		
H. 3400 mm.	3020 mm.	11073020T		
H. 3600 mm.	3120 mm.	11073120T		
H. 3800 mm.	3220 mm.	11073220T		



MODELLO LEONARDO K2000 PINZA ROVESCIAIA TRAENTE MODEL LEONARDO K2000 TAKER REVERSED HOOK

**MATERIE PRIME
RAW MATERIALS**

 TEFLON,  CARBONIO
 TEFLON,  CARBON FIBER,  POLIESTERE,
 TEFLON,  CARBON FIBER,  POLYESTER,



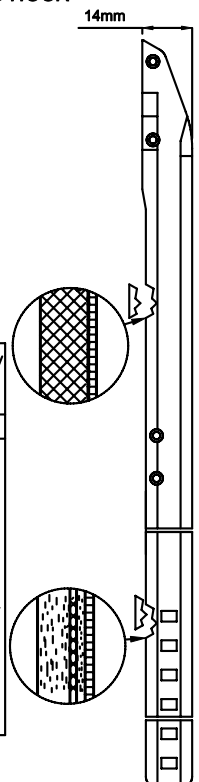



ALT. TELAIO LOOM WIDTH	LUNG. NASTRO TAPE LENGTH	Fibercompositi CODICE/ CODE	VARIANTE/ VARIANT	
			C	S
H. 1700 mm.	2122 mm.	11072122TPR		
H. 1900 mm.	2222 mm.	11072222TPR		
H. 2100 mm.	2322 mm.	11072322TPR		
H. 2200 mm.	2372 mm.	11072372TPR		
H. 2300 mm.	2422 mm.	11072422TPR		
H. 2600 mm.	2572 mm.	11072572TPR		
H. 2800 mm.	2672 mm.	11072672TPR		
H. 3000 mm.	2802 mm.	11072802TPR		
H. 3200 mm.	2902 mm.	11072902TPR		
H. 3400 mm.	3002 mm.	11073002TPR		
H. 3600 mm.	3102 mm.	11073102TPR		
H. 3800 mm.	3202 mm.	11073202TPR		



NASTRI PER TELAI VAMATEX INTERCAMBIABILI CON GLI ORIGINALI RAPIER TAPES FOR VAMATEX LOOMS INTERCHANGEABLE WITH THE ORIGINALS

MODELLO P1001 PORTANTE MODEL P1001 BRINGER

MATERIE PRIME
 RAW MATERIALS





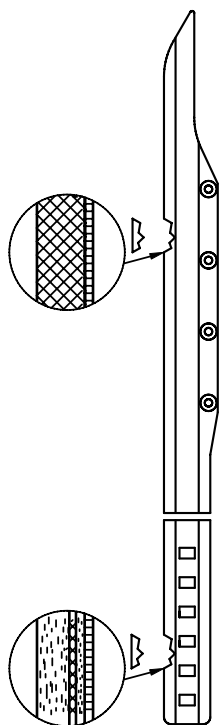

 TEFLON,
  CARBONIO,
  POLIESTERE
 TEFLON,
  CARBON FIBER,
  POLYESTER,

ALT. TELAIO LOOM WIDTH	LUNG. NASTRO TAPE LENGTH	Fibercompositi CODICE / CODE
H. 1600 mm.	2190 mm.	11012190P
H. 1900 mm.	2340 mm.	11012340P
H. 2100 mm.	2440 mm.	11012440P
H. 2300 mm.	2540 mm.	11012540P
H. 2600 mm.	2690 mm.	11012690P
H. 2800 mm.	2820 mm.	11012820P
H. 3000 mm.	2920 mm.	11012920P
H. 3200 mm.	3020 mm.	11013020P
H. 3400 mm.	3120 mm.	11013120P
H. 3600 mm.	3220 mm.	11013220P
H. 3800 mm.	3320 mm.	11013320P



MODELLO P1001 TRAENTE MODEL P1001 TAKER

MATERIE PRIME
 RAW MATERIALS

 TEFLON,
  CARBONIO,
  POLIESTERE
 TEFLON,
  CARBON FIBER,
  POLYESTER,

ALT. TELAIO LOOM WIDTH	LUNG. NASTRO TAPE LENGTH	Fibercompositi CODICE / CODE
H. 1600 mm.	2030 mm.	11012030T
H. 1900 mm.	2180 mm.	11012180T
H. 2100 mm.	2280 mm.	11012280T
H. 2300 mm.	2380 mm.	11012380T
H. 2600 mm.	2530 mm.	11012530T
H. 2800 mm.	2660 mm.	11012660T
H. 3000 mm.	2760 mm.	11012760T
H. 3200 mm.	2860 mm.	11012860T
H. 3400 mm.	2960 mm.	11012960T
H. 3600 mm.	3060 mm.	11013060T
H. 3800 mm.	3160 mm.	11013160T

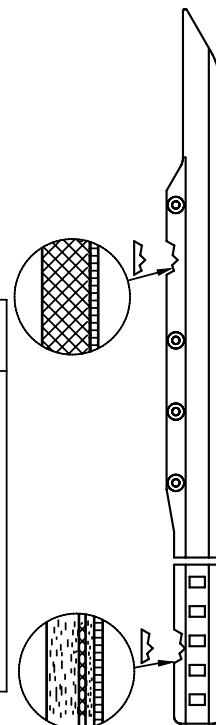

MODELLO P1001 PUNTA INTERCAMBIABILE PORTANTE MODEL P1001 INTERCHANGEABLE TOP BRINGER

MATERIE PRIME
 RAW MATERIALS

 TEFLON,
  CARBONIO,
  POLIESTERE
 TEFLON,
  CARBON FIBER,
  POLYESTER,

ALT. TELAIO LOOM WIDTH	LUNG. NASTRO TAPE LENGTH	Fibercompositi CODICE / CODE
H. 1600 mm.	2130 mm.	11022130PPI
H. 1900 mm.	2280 mm.	11022280PPI
H. 2100 mm.	2380 mm.	11022380PPI
H. 2300 mm.	2480 mm.	11022480PPI
H. 2600 mm.	2630 mm.	11022630PPI
H. 2800 mm.	2730 mm.	11022730PPI
H. 3000 mm.	2860 mm.	11022860PPI
H. 3200 mm.	2960 mm.	11022960PPI
H. 3400 mm.	3060 mm.	11023060PPI
H. 3600 mm.	3160 mm.	11023160PPI
H. 3800 mm.	3260 mm.	11023260PPI

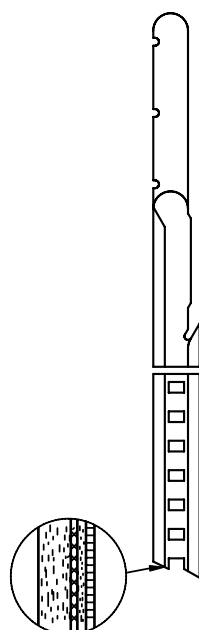

MODELLO P1001 PUNTA INTERCAMBIABILE TRAENTE MODEL P1001 INTERCHANGEABLE TOP TAKER

MATERIE PRIME
 RAW MATERIALS

 TEFLON,
  CARBONIO,
  POLIESTERE
 TEFLON,
  CARBON FIBER,
  POLYESTER,

ALT. TELAIO LOOM WIDTH	LUNG. NASTRO TAPE LENGTH	Fibercompositi CODICE / CODE
H. 1600 mm.	1945 mm.	11021945TPI
H. 1900 mm.	2095 mm.	11022095TPI
H. 2100 mm.	2195 mm.	11022195TPI
H. 2300 mm.	2295 mm.	11022295TPI
H. 2600 mm.	2445 mm.	11022445TPI
H. 2800 mm.	2545 mm.	11022545TPI
H. 3000 mm.	2675 mm.	11022675TPI
H. 3200 mm.	2775 mm.	11022775TPI
H. 3400 mm.	2875 mm.	11022875TPI
H. 3600 mm.	2975 mm.	11022975TPI
H. 3800 mm.	3075 mm.	11023075TPI

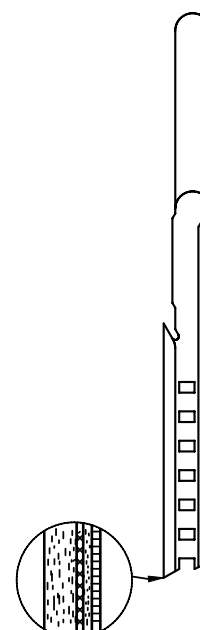

NASTRI PER TELAI VAMATEX INTERCambiabili CON GLI ORIGINALI RAPIER TAPES FOR VAMATEX LOOMS INTERCHANGEABLE WITH THE ORIGINALS

**MODELLO 401
MODEL 401**
**MATERIE PRIME
RAW MATERIALS**
 TEFLON
 TEFLON

 CARBONIO
 CARBON FIBER

 POLIESTERE
 POLYESTER

ALT. TELAI LOOM WIDTH	LUNG. NASTRO TAPE LENGTH	Fibercompositi CODICE/ CODE	VARIANTE VARIANT	
			C	S
H. 1600 mm.	1780 mm.	11041780		
H. 1900 mm.	1920 mm.	11041920		
H. 2100 mm.	2015 mm.	11042015		
H. 2300 mm.	2110 mm.	11042110		
H. 2600 mm.	2275 mm.	11042275		
H. 3000 mm.	2515 mm.	11042515		
H. 3200 mm.	2610 mm.	11042610		
H. 3400 mm.	2705 mm.	11042705		
H. 3600 mm.	2800 mm.	11042800		
H. 3800 mm.	2895 mm.	11042895		

PER COTONE / FOR COTTON
PER SETA / FOR SILK

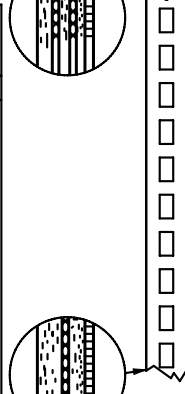
**MODELLO 201
MODEL 201**
**MATERIE PRIME
RAW MATERIALS**
 TEFLON
 TEFLON

 POLIESTERE
 POLYESTER

ALT. TELAI LOOM WIDTH	LUNG. NASTRO TAPE LENGTH	Fibercompositi CODICE/ CODE	VARIANTE VARIANT	
			C	S
H. 1900 mm.	1750 mm.	11051750		
H. 2200 mm.	1900 mm.	11051900		
H. 2600 mm.	2100 mm.	11052100		
H. 3000 mm.	2300 mm.	11052300		
H. 3400 mm.	2500 mm.	11052500		
H. 3600 mm.	2580 mm.	11052580		

PER COTONE / FOR COTTON
PER SETA / FOR SILK

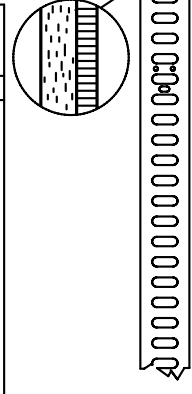

**MODELLO 201/401
MODEL 201/401**
**MATERIE PRIME
RAW MATERIALS**
 TEFLON
 TEFLON

 POLIESTERE.
 POLYESTER

ALT. TELAI LOOM WIDTH	LUNG. NASTRO TAPE LENGTH	Fibercompositi CODICE/ CODE	VARIANTE/ VARIANT	
			C	S
H. 1900 mm.	1800 mm.	11061800		
H. 2200 mm.	1950 mm.	11061950		
H. 2300 mm.	2000 mm.	11062000		
H. 2600 mm.	2150 mm.	11062150		
H. 3000 mm.	2350 mm.	11062350		
H. 3400 mm.	2550 mm.	11062550		
H. 3600 mm.	2630 mm.	11062630		

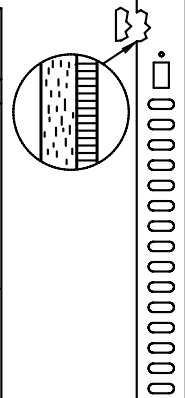
PER COTONE / FOR COTTON
PER SETA / FOR SILK

**MODELLO 201/401 CON PIASTRINA
MODEL 201/401 WITH PLATE**
**MATERIE PRIME
RAW MATERIALS**
 TEFLON
 TEFLON

 POLIESTERE
 POLYESTER

ALT. TELAI LOOM WIDTH	LUNG. NASTRO TAPE LENGTH	Fibercompositi CODICE/ CODE	VARIANTE/ VARIANT	
			C	S
H. 1900 mm.	1800 mm.	11061800P		
H. 2200 mm.	1950 mm.	11061950P		
H. 2300 mm.	2000 mm.	11062000P		
H. 2600 mm.	2150 mm.	11062150P		
H. 3000 mm.	2350 mm.	11062350P		
H. 3400 mm.	2550 mm.	11062550P		
H. 3600 mm.	2630 mm.	11062630P		

PER COTONE / FOR COTTON
PER SETA / FOR SILK

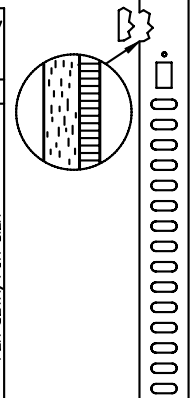

NASTRI PER TELAI VAMATEX INTERCambiabili CON GLI ORIGINALI RAPIER TAPES FOR VAMATEX LOOMS INTERCHANGEABLE WITH THE ORIGINALS

MODELLO 9000 PLUS PER PANNO SPESSORE 3mm
 MODEL 9000 PLUS FOR CLOTH THICKNESS 3mm

MATERIE PRIME
 RAW MATERIALS

TEFLON, CARBONIO POLIESTERE
 TEFLON, CARBON FIBER, POLYESTER,

ALT. TELAIO LOOM WIDTH	LUNG. NASTRO TAPE LENGTH	Fibercompositi CODICE/CODE
H. 1900 mm.	2450 mm.	11032450P
H. 2100 mm.	2550 mm.	11032550P
H. 2300 mm.	2650 mm.	11032650P
H. 2600 mm.	2800 mm.	11032800P
H. 2800 mm.	2900 mm.	11032900P
H. 3000 mm.	3030 mm.	11033030P
H. 3200 mm.	3130 mm.	11033130P
H. 3400 mm.	3230 mm.	11033230P
H. 3600 mm.	3330 mm.	11033330P
H. 3800 mm.	3430 mm.	11033430P

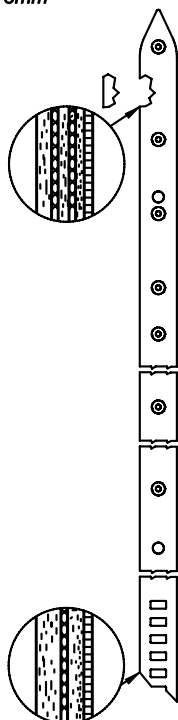

PARTI DI RICAMBIO PER TELAI VAMATEX INTERCambiabili CON GLI ORIGINALI
SPARE PARTS FOR VAMATEX LOOMS INTERCHANGEABLE WITH THE ORIGINALS

PUNTA INTERCambiabile PER P1001 PORTANTE
 INTERCHANGEABLE TOP FOR P1001 BRINGER

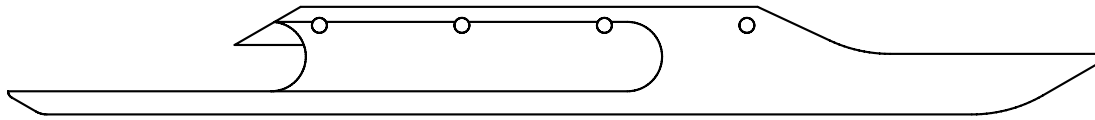

SPESSORE 4mm
 THICKNESS 4mm
 COD.1108096B



SPESSORE 6.5mm
 THICKNESS 6.5mm
 COD.1110098

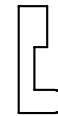

PUNTA INTERCambiabile PER P1001 TRAENTE
 INTERCHANGEABLE TOP FOR P1001 TAKER

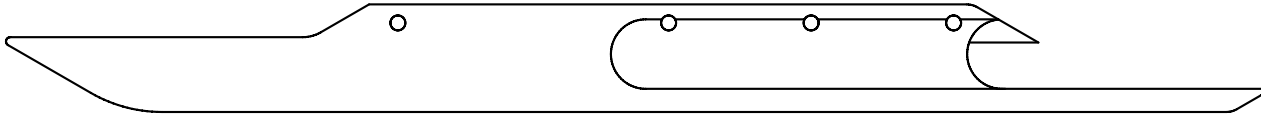

SPESSORE 4mm
 THICKNESS 4mm
 COD.1109100B



SPESSORE 6.5mm
 THICKNESS 6.5mm
 COD.1111102

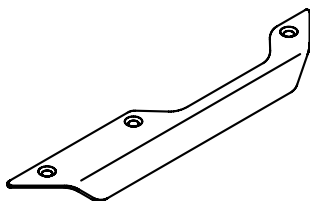
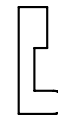

COD.1112416

ALETTA GUIDA PER PINZA PORTANTE P401 S
 LH GRIPPER WING FOR P401 S LOOM

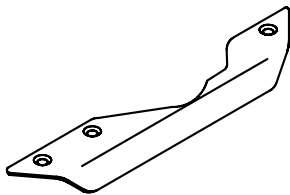

COD.1113418

ALETTA GUIDA PER PINZA TRAENTE P401 S
 RH GRIPPER WING FOR P401 S LOOM

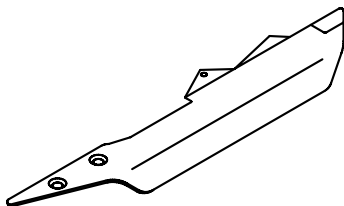

COD.1114412

ALETTA GUIDA PER PINZA PORTANTE P1001
 LH GRIPPER WING FOR P1001 LOOM

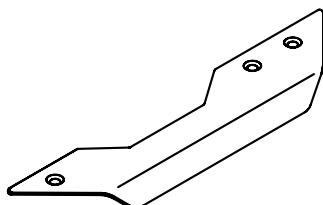

COD.1115406

ALETTA GUIDA PER PINZA TRAENTE P1001
 RH GRIPPER WING FOR P1001 S LOOM

PARTI DI RICAMBIO PER TELAI VAMATEX INTERCAMBIABILI CON GLI ORIGINALI
SPARE PARTS FOR VAMATEX LOOMS INTERCHANGEABLE WITH THE ORIGINALS

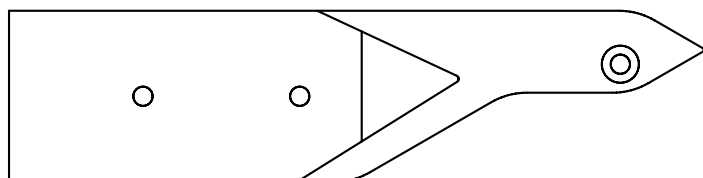

COD.1116162
NUOVA PIASTRINA PER PUNTA NASTRO 401
NEW PLATE FOR POINT OF TAPE 401

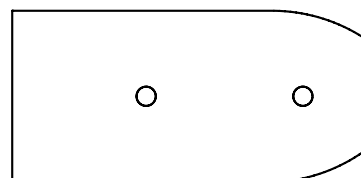

COD.1117266
PIASTRINA PER PUNTA NASTRO 401
PLATE FOR POINT OF TAPE 401

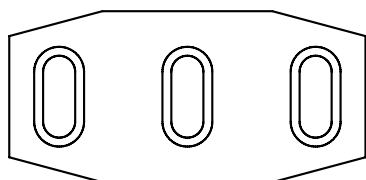

COD.1133064
PIASTRINA DI REAZIONE P1001
REACTION PLATE P1001

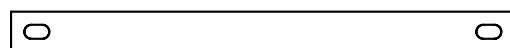

COD.1118132
LAMINA DI TRAZIONE IN CARBONIO PER PINZA 401
CARBON LAMEL 401

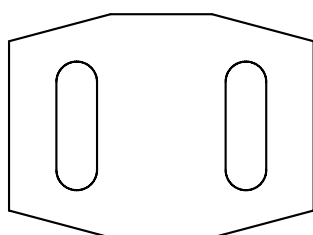

COD.1119024
PIASTRINA APRIPINZA PER 401
OPENING PLATE FOR 401

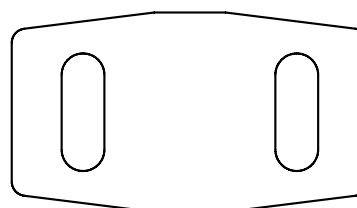

COD.1120054
PIASTRINA APRIPINZA PER P1001
OPENING PLATE FOR P1001

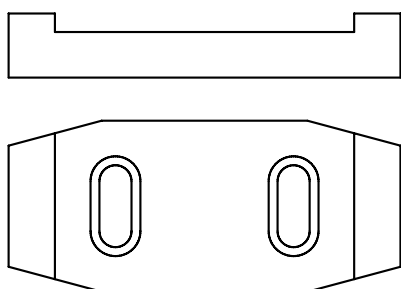

COD.1134096
PIASTRINA DI REAZIONE LEONARDO
REACTION PLATE LEONARDO

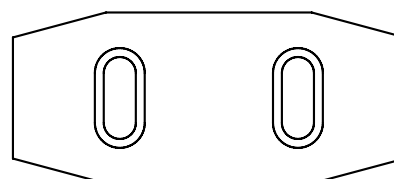

COD.1136066
PIASTRINA DI REAZIONE
REACTION PLATE

PARTI DI RICAMBIO PER TELAI VAMATEX INTERCambiabili CON GLI ORIGINALI
SPARE PARTS FOR VAMATEX LOOMS INTERCHANGEABLE WITH THE ORIGINALS

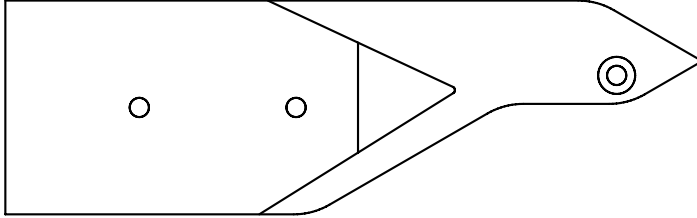

COD.1122194
 NUOVA PIASTRINA PER PUNTA NASTRO 201
 NEW PLATE FOR POINT OF TAPE 201

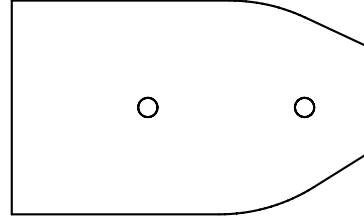

COD.1132696
 PIASTRINA PER PUNTA NASTRO 201
 PLATE FOR POINT OF TAPE 201

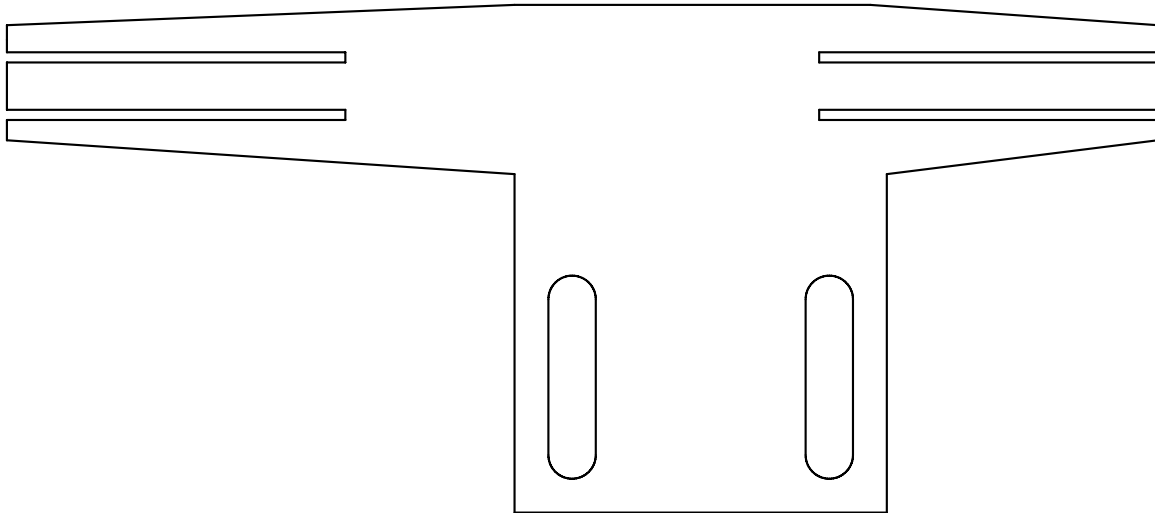

COD.1123032
 PIASTRINA APRIPINZA
 GRIPPER OPENING PLATE

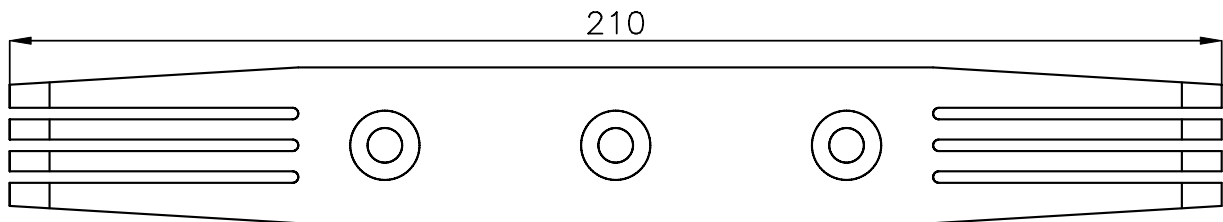

COD.1121056/042
 PIASTRA APRIPINZA PER P1001
 GRIPPER OPENING SLIDING BLOCK FOR P1001

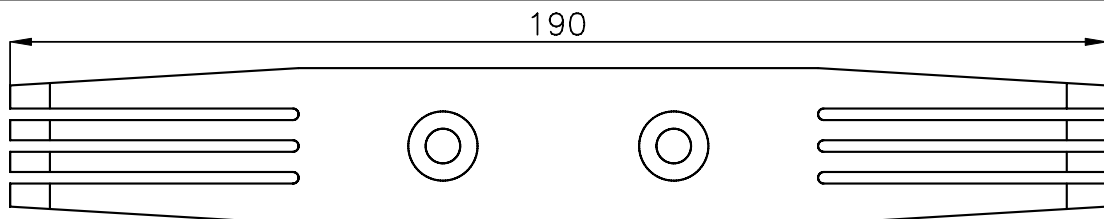

COD.1140
 PIASTRA APRIPINZA PER 401
 GRIPPER OPENING SLIDING BLOCK FOR 401

PARTI DI RICAMBIO PER TELAI VAMATEX INTERCambiabili CON GLI ORIGINALI
SPARE PARTS FOR VAMATEX LOOMS INTERCHANGEABLE WITH THE ORIGINALS

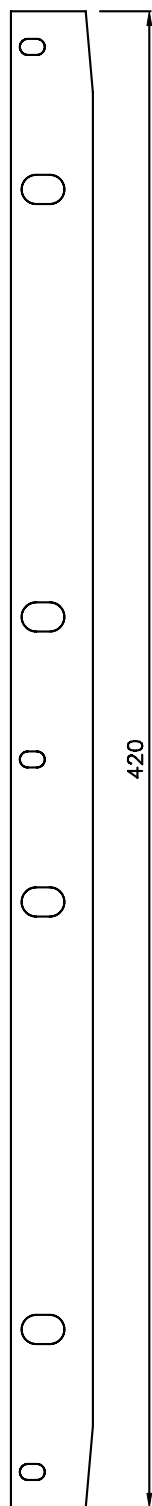

COD.1138114

APRIPINZA TRARENTE
 LEONARDO K2000
 OPENER PLATE TAKER
 LEONARDO K2000

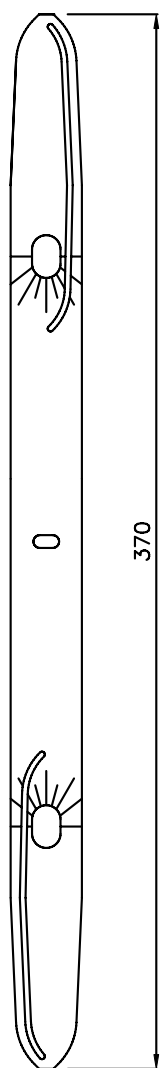

COD.1125110

PIASTRA APRIPINZA
 LEONARDO K2000
 OPENER PLATE
 LEONARDO K2000

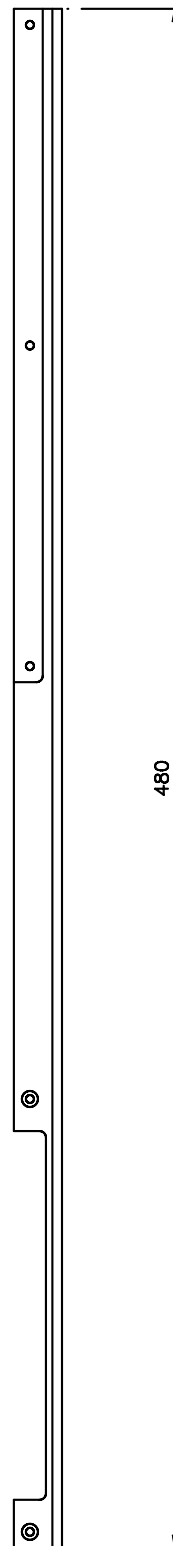

COD.1126120

PATTINO DI REAZIONE PINZA
 PORTANTE LEONARDO K2000
 REACTION PLATE FOR
 LEONARDO K2000 LEFT GRIPPER

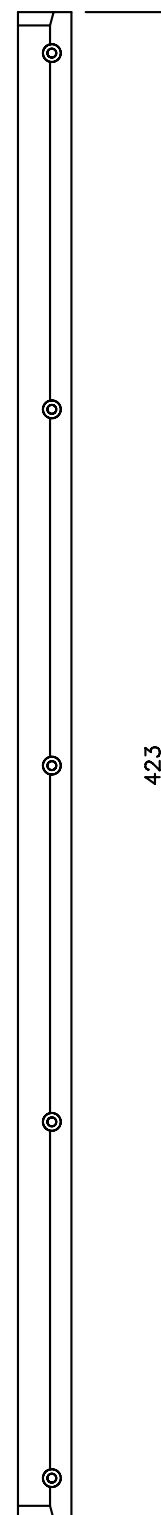

COD.1137092

PATTINO DI REAZIONE PINZA
 TRARENTE LEONARDO K2000
 REACTION PLATE FOR
 LEONARDO K2000 RIGHT GRIPPER

PARTI DI RICAMBIO PER TELAI VAMATEX INTERCambiABILI CON GLI ORIGINALI
SPARE PARTS FOR VAMATEX LOOMS INTERCHANGEABLE WITH THE ORIGINALS

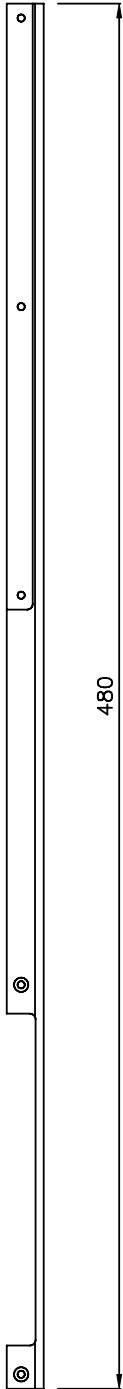

COD.1127122

PATTINO DI REAZIONE
 PER P1001
 SUPPORT PLATE
 FOR P1001

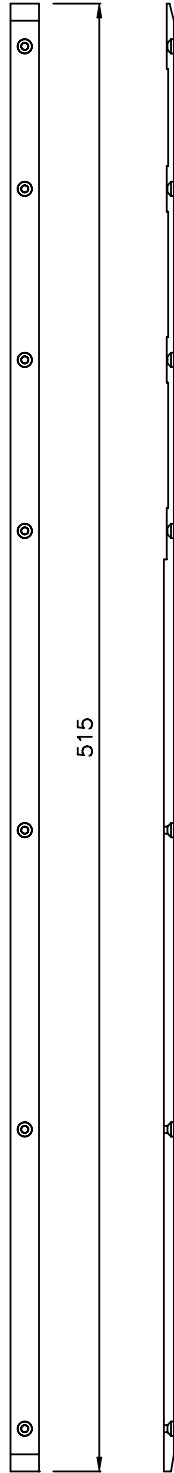

COD.1128086
 PATTINO DI SOSTEGNO
 PER P1001
 SUPPORT PLATE
 FOR P1001

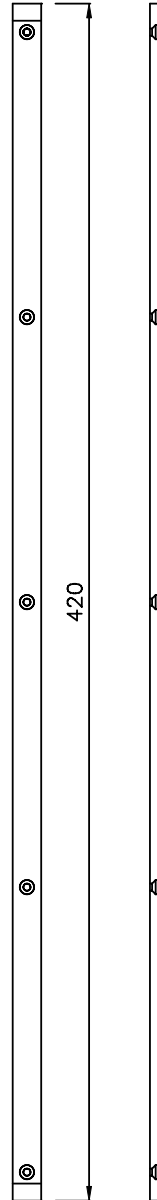

COD.1129068

PATTINO DI REAZIONE
 PER P1001
 SUPPORT PLATE
 FOR P1001



COD.1139116
 APRIPINZA LEONARDO
 PER FTS
 OPENER PLATE
 FOR FTS

NASTRI PER TELAI SOMET INTERCambiabili CON GLI ORIGINALI RAPIER TAPES FOR SOMET LOOMS INTERCHANGEABLE WITH THE ORIGINALS

MODELLO ALPHA GFG MODEL ALPHA GFG

ALT. TELAIO LOOM WIDTH	LUNG. NASTRO TAPE LENGTH	Fibercompositi CODICE / CODE
H. 1700 mm.	2175 mm.	10322175
H. 1900 mm.	2258 mm.	10322258
H. 2100 mm.	2357 mm.	10322357
H. 2200 mm.	2398 mm.	10322398
H. 2300 mm.	2456 mm.	10322456
H. 2600 mm.	2663 mm.	10322663
H. 2800 mm.	2763 mm.	10322763
H. 3000 mm.	2862 mm.	10322862
H. 3200 mm.	2961 mm.	10322961
H. 3400 mm.	3060 mm.	10323060
H. 3600 mm.	3168 mm.	10323168
H. 3800 mm.	3267 mm.	10323267
H. 4000 mm.	3366 mm.	10323366
H. 4200 mm.	3466 mm.	10323466
H. 4600 mm.	3665 mm.	10323665



MODELLO ALPHA MFG SINISTRO MODEL ALPHA MFG LEFT

ALT. TELAIO LOOM WIDTH	LUNG. NASTRO TAPE LENGTH	Fibercompositi CODICE / CODE
H. 1700 mm.	2285 mm.	10332285L
H. 1900 mm.	2360 mm.	10332360L
H. 2100 mm.	2459 mm.	10332459L
H. 2200 mm.	2508 mm.	10332508L
H. 2300 mm.	2558 mm.	10332558L
H. 2600 mm.	2772 mm.	10332772L
H. 2800 mm.	2871 mm.	10332871L
H. 3000 mm.	2970 mm.	10332970L
H. 3200 mm.	3069 mm.	10333069L
H. 3400 mm.	3168 mm.	10333168L
H. 3600 mm.	3267 mm.	10333267L
H. 3800 mm.	3374 mm.	10333374L
H. 4000 mm.	3473 mm.	10333473L
H. 4200 mm.	3671 mm.	10333671L
H. 4600 mm.	4076 mm.	10334076L

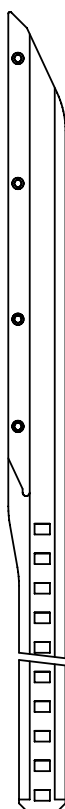

MODELLO ALPHA MFG DESTRO MODEL ALPHA MFG RIGHT



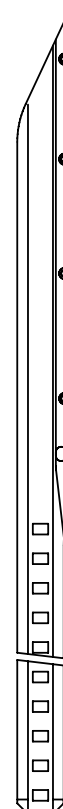



ALT. TELAIO LOOM WIDTH	LUNG. NASTRO TAPE LENGTH	Fibercompositi CODICE / CODE
H. 1700 mm.	2285 mm.	10332285R
H. 1900 mm.	2360 mm.	10332360R
H. 2100 mm.	2459 mm.	10332459R
H. 2200 mm.	2508 mm.	10332508R
H. 2300 mm.	2558 mm.	10332558R
H. 2600 mm.	2772 mm.	10332772R
H. 2800 mm.	2871 mm.	10332871R
H. 3000 mm.	2970 mm.	10332970R
H. 3200 mm.	3069 mm.	10333069R
H. 3400 mm.	3168 mm.	10333168R
H. 3600 mm.	3267 mm.	10333267R
H. 3800 mm.	3374 mm.	10333374R
H. 4000 mm.	3473 mm.	10333473R
H. 4200 mm.	3671 mm.	10333671R
H. 4600 mm.	4076 mm.	10334076R



NASTRI PER TELAI SOMET INTERCAMBIABILI CON GLI ORIGINALI RAPIER TAPES FOR SOMET LOOMS INTERCHANGEABLE WITH THE ORIGINALS

MODELLO THEMA 11 EXCEL M.F.G. PORTANTE
MODEL THEMA 11 EXCEL M.F.G. BRINGER

MATERIE PRIME
RAW MATERIALS



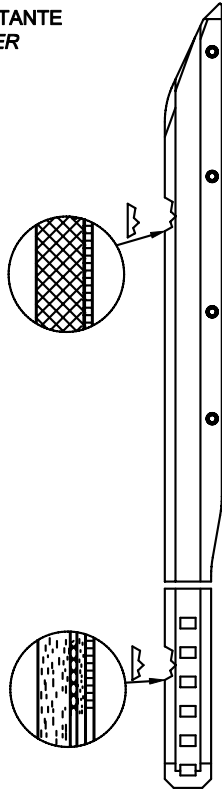

 TEFLON,
  CARBONIO,
  POLIESTERE
 TEFLON,
  CARBON FIBER,
  POLYESTER,

ALT. TELAIO LOOM WIDTH	LUNG. NASTRO TAPE LENGTH	Fibercompositi CODICE/CODE
H. 1650 mm.	2128 mm.	10082128P
H. 1900 mm.	2252 mm.	10082252P
H. 2100 mm.	2351 mm.	10082351P
H. 2200 mm.	2400 mm.	10082400P
H. 2300 mm.	2450 mm.	10082450P
H. 2600 mm.	2664 mm.	10082664P
H. 2800 mm.	2763 mm.	10082763P
H. 3000 mm.	2862 mm.	10082862P
H. 3200 mm.	2961 mm.	10082961P
H. 3400 mm.	3060 mm.	10083060P
H. 3600 mm.	3159 mm.	10083159P
H. 3800 mm.	3267 mm.	10083267P
H. 4000 mm.	3366 mm.	10083366P



MODELLO THEMA 11 EXCEL M.F.G. TRAENTE
MODEL THEMA 11 EXCEL M.F.G. TAKER

MATERIE PRIME
RAW MATERIALS





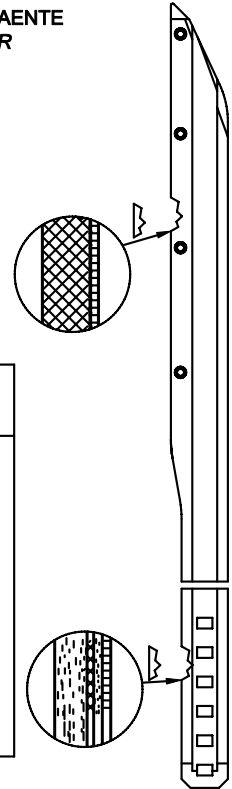

 TEFLON,
  CARBONIO,
  POLIESTERE
 TEFLON,
  CARBON FIBER,
  POLYESTER,

ALT. TELAIO LOOM WIDTH	LUNG. NASTRO TAPE LENGTH	Fibercompositi CODICE/CODE
H. 1650 mm.	2128 mm.	10082128T
H. 1900 mm.	2252 mm.	10082252T
H. 2100 mm.	2351 mm.	10082351T
H. 2200 mm.	2400 mm.	10082400T
H. 2300 mm.	2450 mm.	10082450T
H. 2600 mm.	2664 mm.	10082664T
H. 2800 mm.	2763 mm.	10082763T
H. 3000 mm.	2862 mm.	10082862T
H. 3200 mm.	2961 mm.	10082961T
H. 3400 mm.	3060 mm.	10083060T
H. 3600 mm.	3159 mm.	10083159T
H. 3800 mm.	3267 mm.	10083267T
H. 4000 mm.	3366 mm.	10083366T



MODELLO THEMA 11 EXCEL M.F.G. PORTANTE
PUNTA INTERCAMBIABILE
MODEL THEMA 11 EXCEL M.F.G. BRINGER
INTERCHANGEABLE TOP

MATERIE PRIME
RAW MATERIALS





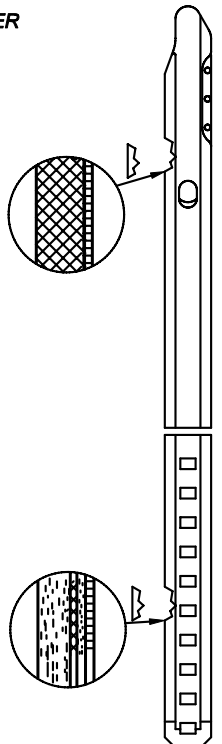

 TEFLON,
  CARBONIO,
  POLIESTERE
 TEFLON,
  CARBON FIBER,
  POLYESTER,

ALT. TELAIO LOOM WIDTH	LUNG. NASTRO TAPE LENGTH	Fibercompositi CODICE/CODE
H. 1650 mm.	1980 mm.	10091980PPI
H. 1900 mm.	2104 mm.	10092104PPI
H. 2100 mm.	2203 mm.	10092203PPI
H. 2200 mm.	2252 mm.	10092252PPI
H. 2300 mm.	2302 mm.	10092302PPI
H. 2600 mm.	2516 mm.	10092516PPI
H. 2800 mm.	2615 mm.	10092615PPI
H. 3000 mm.	2714 mm.	10092714PPI
H. 3200 mm.	2813 mm.	10092813PPI
H. 3400 mm.	2912 mm.	10092912PPI
H. 3600 mm.	3011 mm.	10093011PPI
H. 3800 mm.	3119 mm.	10093119PPI
H. 4000 mm.	3218 mm.	10093218PPI



MODELLO THEMA 11 EXCEL M.F.G. TRAENTE
PUNTA INTERCAMBIABILE
MODEL THEMA 11 EXCEL M.F.G. TAKER
INTERCHANGEABLE TOP

MATERIE PRIME
RAW MATERIALS

 TEFLON,
  CARBONIO,
  POLIESTERE
 TEFLON,
  CARBON FIBER,
  POLYESTER,

ALT. TELAIO LOOM WIDTH	LUNG. NASTRO TAPE LENGTH	Fibercompositi CODICE/CODE
H. 1650 mm.	1980 mm.	10091980TPI
H. 1900 mm.	2104 mm.	10092104TPI
H. 2100 mm.	2203 mm.	10092203TPI
H. 2200 mm.	2252 mm.	10092252TPI
H. 2300 mm.	2302 mm.	10092302TPI
H. 2600 mm.	2516 mm.	10092516TPI
H. 2800 mm.	2615 mm.	10092615TPI
H. 3000 mm.	2714 mm.	10092714TPI
H. 3200 mm.	2813 mm.	10092813TPI
H. 3400 mm.	2912 mm.	10092912TPI
H. 3600 mm.	3011 mm.	10093011TPI
H. 3800 mm.	3119 mm.	10093119TPI
H. 4000 mm.	3218 mm.	10093218TPI

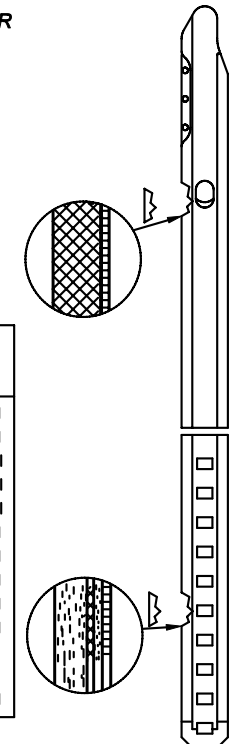

NASTRI PER TELAI SOMET INTERCAMBIABILI CON GLI ORIGINALI RAPIER TAPES FOR SOMET LOOMS INTERCHANGEABLE WITH THE ORIGINALS

MODELLO THEMA 11E-104 MODEL THEMA 11E-104

MATERIE PRIME
RAW MATERIALS

TEFLON CARBONIO POLIESTERE
 TEFLON, CARBON FIBER, POLYESTER,

ALT. TELAIO LOOM WIDTH	LUNG. NASTRO TAPE LENGTH	Fibercompositi CODICE/ CODE	VARIANTE/ VARIANT	
			C	S
H. 1650 mm.	2055.8 mm.	10012055		
H. 1900 mm.	2187.4 mm.	10012187		
H. 2100 mm.	2286.6 mm.	10012286		
H. 2200 mm.	2330.0 mm.	10012330		
H. 2300 mm.	2384.8 mm.	10012384		
H. 2600 mm.	2593.3 mm.	10012593		
H. 2800 mm.	2692.0 mm.	10012692		
H. 3000 mm.	2790.8 mm.	10012790		
H. 3200 mm.	2889.5 mm.	10012889		
H. 3400 mm.	2988.2 mm.	10012988		
H. 3600 mm.	3097.9 mm.	10013097		
H. 3800 mm.	3196.6 mm.	10013196		
H. 4000 mm.	3295.4 mm.	10013295		
H. 4200 mm.	3394.0 mm.	10013394		
H. 4600 mm.	3591.0 mm.	10013591		

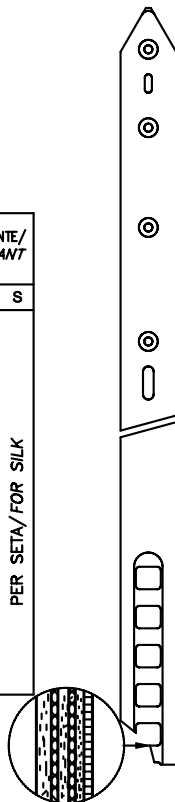

MODELLO THEMA 11 MODEL THEMA 11

MATERIE PRIME
RAW MATERIALS

TEFLON CARBONIO POLIESTERE
 TEFLON, CARBON FIBER, POLYESTER,

ALT. TELAIO LOOM WIDTH	LUNG. NASTRO TAPE LENGTH	Fibercompositi CODICE/ CODE	VARIANTE/ VARIANT	
			C	S
H. 1650 mm.	2099.2 mm.	10032099		
H. 1900 mm.	2208.9 mm.	10032208		
H. 2100 mm.	2362.4 mm.	10032362		
H. 2200 mm.	2362.4 mm.	10032362		
H. 2300 mm.	2417.6 mm.	10032417		
H. 2600 mm.	2625.7 mm.	10032625		
H. 2800 mm.	2724.6 mm.	10032724		
H. 3000 mm.	2922.6 mm.	10032922		
H. 3200 mm.	2922.6 mm.	10032922		
H. 3400 mm.	3020.6 mm.	10033020		
H. 3600 mm.	3130.3 mm.	10033130		
H. 3800 mm.	3218.1 mm.	10033218		
H. 4000 mm.	3405.6 mm.	10033405		
H. 4200 mm.	3525.3 mm.	10033525		
H. 4600 mm.	3744.7 mm.	10033744		

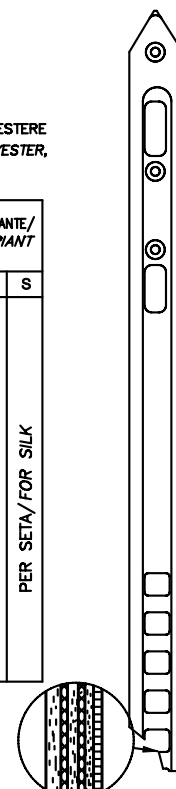

MODELLO THEMA C2 MODEL THEMA C2

MATERIE PRIME
RAW MATERIALS

TEFLON CARBONIO POLIESTERE
 TEFLON, CARBON FIBER, POLYESTER,

ALT. TELAIO LOOM WIDTH	LUNG. NASTRO TAPE LENGTH	Fibercompositi CODICE/ CODE	VARIANTE/ VARIANT	
			C	S
H. 1650 mm.	2099.2 mm.	10022099C2		
H. 1900 mm.	2208.9 mm.	10022208C2		
H. 2100 mm.	2362.4 mm.	10022362C2		
H. 2200 mm.	2362.4 mm.	10022362C2		
H. 2300 mm.	2417.6 mm.	10022417C2		
H. 2600 mm.	2625.7 mm.	10022625C2		
H. 2800 mm.	2724.6 mm.	10022724C2		
H. 3000 mm.	2922.6 mm.	10022922C2		
H. 3200 mm.	2922.6 mm.	10022922C2		
H. 3400 mm.	3020.6 mm.	10023020C2		
H. 3600 mm.	3130.3 mm.	10023130C2		
H. 3800 mm.	3218.1 mm.	10023218C2		
H. 4000 mm.	3405.6 mm.	10023405C2		
H. 4200 mm.	3525.3 mm.	10023525C2		
H. 4600 mm.	3744.7 mm.	10023744C2		

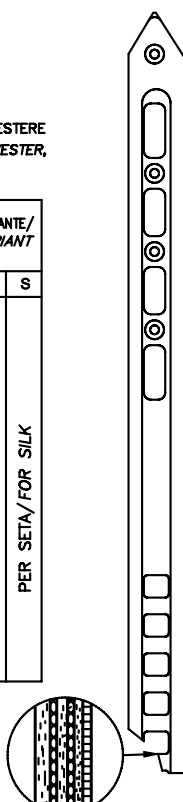

MODELLO THEMA C1 MODEL THEMA C1

MATERIE PRIME
RAW MATERIALS

TEFLON CARBONIO POLIESTERE
 TEFLON, CARBON FIBER, POLYESTER,

ALT. TELAIO LOOM WIDTH	LUNG. NASTRO TAPE LENGTH	Fibercompositi CODICE/ CODE	VARIANTE/ VARIANT	
			C	S
H. 1650 mm.	2099.2 mm.	10022099C1		
H. 1900 mm.	2208.9 mm.	10022208C1		
H. 2100 mm.	2362.4 mm.	10022362C1		
H. 2200 mm.	2362.4 mm.	10022362C1		
H. 2300 mm.	2417.6 mm.	10022417C1		
H. 2600 mm.	2625.7 mm.	10022625C1		
H. 2800 mm.	2724.6 mm.	10022724C1		
H. 3000 mm.	2922.6 mm.	10022922C1		
H. 3200 mm.	2922.6 mm.	10022922C1		
H. 3400 mm.	3020.6 mm.	10023020C1		
H. 3600 mm.	3130.3 mm.	10023130C1		
H. 3800 mm.	3218.1 mm.	10023218C1		
H. 4000 mm.	3405.6 mm.	10023405C1		
H. 4200 mm.	3525.3 mm.	10023525C1		
H. 4600 mm.	3744.7 mm.	10023744C1		

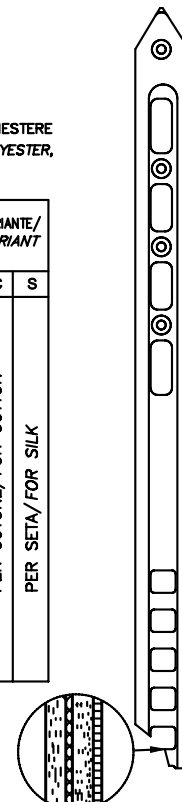

NASTRI PER TELAI SOMET INTERCambiabili con GLI ORIGINALI RAPIER TAPES FOR SOMET LOOMS INTERCHANGEABLE WITH THE ORIGINALS

MODELLO MASTER SM92/93 C1 MODEL MASTER SM92/93 C1

MATERIE PRIME
RAW MATERIALS

TEFLON CARBONIO POLIESTERE
 TEFLON, CARBON FIBER, POLYESTER,

ALT. TELAIO LOOM WIDTH	LUNG. NASTRO TAPE LENGTH	Fibercompositi CODICE/ CODE	VARIANTE/ VARIANT	
			C	S
H. 1650 mm.	1891.1 mm.	10041891C1		
H. 1900 mm.	2000.6 mm.	10042000C1		
H. 2100 mm.	2154.6 mm.	10042154C1		
H. 2200 mm.	2154.6 mm.	10042154C1		
H. 2300 mm.	2198.6 mm.	10042198C1		
H. 2600 mm.	2417.6 mm.	10042417C1		
H. 2800 mm.	2527.6 mm.	10042527C1		
H. 3000 mm.	2724.6 mm.	10042724C1		
H. 3200 mm.	2724.6 mm.	10042724C1		
H. 3400 mm.	2812.6 mm.	10042812C1		
H. 3600 mm.	2922.6 mm.	10042922C1		
H. 3800 mm.	3010.6 mm.	10043010C1		
H. 4000 mm.	3207.6 mm.	10043207C1		
H. 4200 mm.	3207.6 mm.	10043207C1		
H. 4600 mm.	3405.6 mm.	10043405C1		

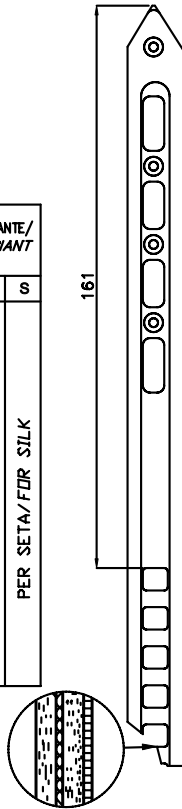

MODELLO MASTER SM92/93 C2 MODEL MASTER SM92/93 C2

MATERIE PRIME
RAW MATERIALS

TEFLON CARBONIO POLIESTERE
 TEFLON, CARBON FIBER, POLYESTER,

ALT. TELAIO LOOM WIDTH	LUNG. NASTRO TAPE LENGTH	Fibercompositi CODICE/ CODE	VARIANTE/ VARIANT	
			C	S
H. 1650 mm.	1891.1 mm.	10041891C2		
H. 1900 mm.	2000.6 mm.	10042000C2		
H. 2100 mm.	2154.6 mm.	10042154C2		
H. 2200 mm.	2154.6 mm.	10042154C2		
H. 2300 mm.	2198.6 mm.	10042198C2		
H. 2600 mm.	2417.6 mm.	10042417C2		
H. 2800 mm.	2527.6 mm.	10042527C2		
H. 3000 mm.	2724.6 mm.	10042724C2		
H. 3200 mm.	2724.6 mm.	10042724C2		
H. 3400 mm.	2812.6 mm.	10042812C2		
H. 3600 mm.	2922.6 mm.	10042922C2		
H. 3800 mm.	3010.6 mm.	10043010C2		
H. 4000 mm.	3207.6 mm.	10043207C2		
H. 4200 mm.	3207.6 mm.	10043207C2		
H. 4600 mm.	3405.6 mm.	10043405C2		

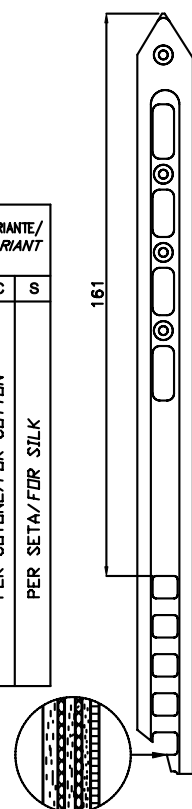

MODELLO MASTER SM92/93 C1 MODEL MASTER SM92/93 C1

MATERIE PRIME
RAW MATERIALS

TEFLON CARBONIO POLIESTERE
 TEFLON, CARBON FIBER, POLYESTER,

ALT. TELAIO LOOM WIDTH	LUNG. NASTRO TAPE LENGTH	Fibercompositi CODICE/ CODE	VARIANTE/ VARIANT	
			C	S
H. 1650 mm.	1891.1 mm.	10041891C1TRL		
H. 1900 mm.	2000.6 mm.	10042000C1TRL		
H. 2100 mm.	2154.6 mm.	10042154C1TRL		
H. 2200 mm.	2154.6 mm.	10042154C1TRL		
H. 2300 mm.	2198.6 mm.	10042198C1TRL		
H. 2600 mm.	2417.6 mm.	10042417C1TRL		
H. 2800 mm.	2527.6 mm.	10042527C1TRL		
H. 3000 mm.	2724.6 mm.	10042724C1TRL		
H. 3200 mm.	2724.6 mm.	10042724C1TRL		
H. 3400 mm.	2812.6 mm.	10042812C1TRL		
H. 3600 mm.	2922.6 mm.	10042922C1TRL		
H. 3800 mm.	3010.6 mm.	10043010C1TRL		
H. 4000 mm.	3207.6 mm.	10043207C1TRL		
H. 4200 mm.	3207.6 mm.	10043207C1TRL		
H. 4600 mm.	3405.6 mm.	10043405C1TRL		

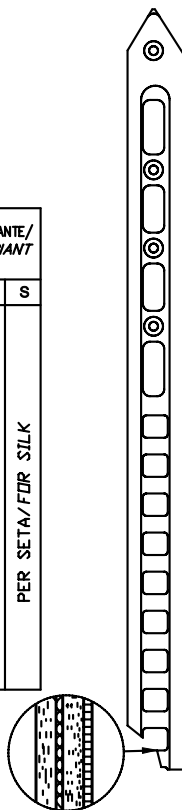

NASTRI PER TELAI SOMET INTERCambiabili CON GLI ORIGINALI RAPIER TAPES FOR SOMET LOOMS INTERCHANGEABLE WITH THE ORIGINALS

MODELLO ST880 COTONIERO MODEL ST880 COTTON

MATERIE PRIME
 RAW MATERIALS

TEFLON DI COLORE GRIGIO
 WHITE GREY TEFLON,
 CARBONIO
 CARBON FIBER,
 POLIESTERE
 POLYESTER,

ALT. TELAIO LOOM WIDTH	LUNG. NASTRO TAPE LENGTH	Fibercompositi CODICE/ CODE
H. 1900 mm.	1956 mm.	10051956C
H. 2100 mm.	2044 mm.	10052044C
H. 2200 mm.	2044 mm.	10052044C
H. 2300 mm.	2154 mm.	10052154C
H. 2600 mm.	2395 mm.	10052395C
H. 3000 mm.	2593 mm.	10052593C
H. 3100 mm.	2593 mm.	10052593C
H. 3400 mm.	2790 mm.	10052790C
H. 3600 mm.	2900 mm.	10052900C

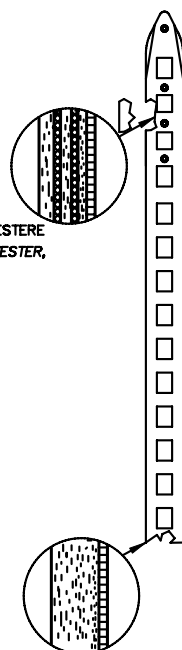

MODELLO ST880 SERICO MODEL ST880 SILK

MATERIE PRIME
 RAW MATERIALS

TEFLON DI COLORE GIALLO,
 YELLOW TEFLON,
 CARBONIO
 CARBON FIBER,
 POLIESTERE
 POLYESTER,

ALT. TELAIO LOOM WIDTH	LUNG. NASTRO TAPE LENGTH	Fibercompositi CODICE/ CODE
H. 1900 mm.	1956 mm.	10051956S
H. 2100 mm.	2044 mm.	10052044S
H. 2200 mm.	2044 mm.	10052044S
H. 2300 mm.	2154 mm.	10052154S
H. 2600 mm.	2395 mm.	10052395S
H. 3000 mm.	2593 mm.	10052593S
H. 3100 mm.	2593 mm.	10052593S
H. 3400 mm.	2790 mm.	10052790S
H. 3600 mm.	2900 mm.	10052900S

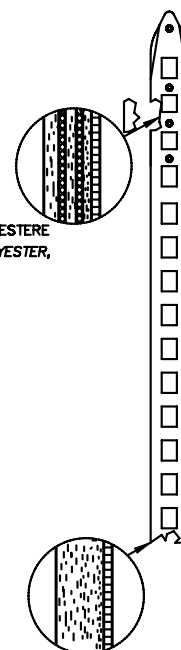

MODELLO UV770 SPESSORE 2.5mm MODEL UV770 THICKNESS 2.5mm

MATERIE PRIME
 RAW MATERIALS

TEFLON,
 TEFLON,
 POLIESTERE
 POLYESTER,

ALT. TELAIO LOOM WIDTH	LUNG. NASTRO TAPE LENGTH	Fibercompositi CODICE/ CODE
H. 1900 mm.	1940 mm.	10071940S25
H. 2100 mm.	2040 mm.	10072040S25
H. 2300 mm.	2140 mm.	10072140S25
H. 2600 mm.	2380 mm.	10072380S25
H. 3000 mm.	2580 mm.	10072580S25
H. 3400 mm.	2780 mm.	10072780S25
H. 3600 mm.	2900 mm.	10072900S25

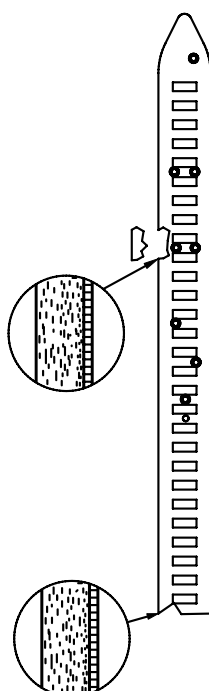

MODELLO UV770 SPESSORE 3mm MODEL UV770 THICKNESS 3mm

MATERIE PRIME
 RAW MATERIALS

TEFLON,
 TEFLON,
 POLIESTERE
 POLYESTER,

ALT. TELAIO LOOM WIDTH	LUNG. NASTRO TAPE LENGTH	Fibercompositi CODICE/ CODE
H. 1900 mm.	1690 mm.	10071690S3
H. 2100 mm.	1790 mm.	10071790S3
H. 2300 mm.	1890 mm.	10071890S3
H. 2600 mm.	2130 mm.	10072130S3
H. 3000 mm.	2330 mm.	10072330S3
H. 3400 mm.	2530 mm.	10072530S3
H. 3600 mm.	2650 mm.	10072650S3

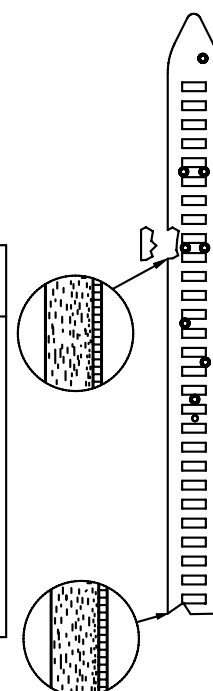

NASTRI PER TELAI SOMET INTERCambiabili CON GLI ORIGINALI RAPIER TAPES FOR SOMET LOOMS INTERCHANGEABLE WITH THE ORIGINALS

MODELLO AC2/S TP2 SINISTRO MODEL AC2/S TP2 LEFT

MATERIE PRIME
 RAW MATERIALS

 POLIESTERE/COTONE
 POLYESTER/COTTON,

ALT. TELAIO LOOM WIDTH	LUNG. NASTRO TAPE LENGTH	Fibercompositi CODICE/CODE
H. 1800 mm.	1900 mm.	10061900T2S
H. 1900 mm.	1900 mm.	10061900T2S
H. 2100 mm.	1900 mm.	10061900T2S
H. 2200 mm.	1900 mm.	10061900T2S
H. 2500 mm.	2450 mm.	10062450T2S
H. 2900 mm.	2450 mm.	10062450T2S
H. 3300 mm.	2450 mm.	10062450T2S
H. 3400 mm.	2450 mm.	10062450T2S
H. 3800 mm.	2700 mm.	10062700T2S
H. 4200 mm.	3100 mm.	10063100T2S
H. 4600 mm.	3400 mm.	10063400T2S

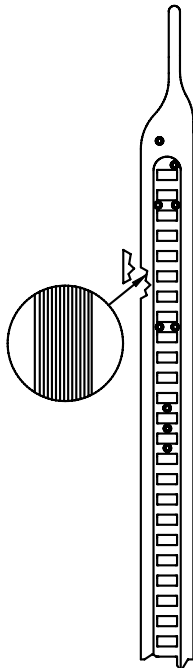

MODELLO AC2/S TP2 DESTRO MODEL AC2/S TP2 RIGHT

MATERIE PRIME
 RAW MATERIALS

 POLIESTERE/COTONE
 POLYESTER/COTTON,

ALT. TELAIO LOOM WIDTH	LUNG. NASTRO TAPE LENGTH	Fibercompositi CODICE/CODE
H. 1800 mm.	1900 mm.	10061900T2D
H. 1900 mm.	1900 mm.	10061900T2D
H. 2100 mm.	1900 mm.	10061900T2D
H. 2200 mm.	1900 mm.	10061900T2D
H. 2500 mm.	2450 mm.	10062450T2D
H. 2900 mm.	2450 mm.	10062450T2D
H. 3300 mm.	2450 mm.	10062450T2D
H. 3400 mm.	2450 mm.	10062450T2D
H. 3800 mm.	2700 mm.	10062700T2D
H. 4200 mm.	3100 mm.	10063100T2D
H. 4600 mm.	3400 mm.	10063400T2D

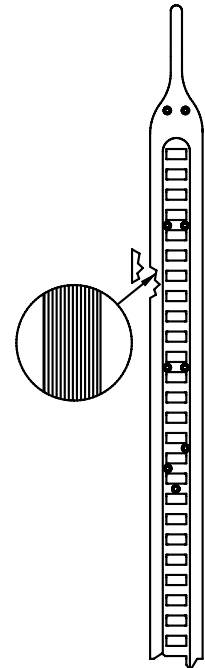

MODELLO AC2/S TP1 SINISTRO MODEL AC2/S TP1 LEFT

MATERIE PRIME
 RAW MATERIALS

 POLIESTERE/COTONE
 POLYESTER/COTTON,

ALT. TELAIO LOOM WIDTH	LUNG. NASTRO TAPE LENGTH	Fibercompositi CODICE/CODE
H. 1800 mm.	1900 mm.	10061900T1S
H. 1900 mm.	1900 mm.	10061900T1S
H. 2100 mm.	1900 mm.	10061900T1S
H. 2200 mm.	1900 mm.	10061900T1S
H. 2500 mm.	2450 mm.	10062450T1S
H. 2900 mm.	2450 mm.	10062450T1S
H. 3300 mm.	2450 mm.	10062450T1S
H. 3400 mm.	2450 mm.	10062450T1S
H. 3800 mm.	2700 mm.	10062700T1S
H. 4200 mm.	3100 mm.	10063100T1S
H. 4600 mm.	3400 mm.	10063400T1S

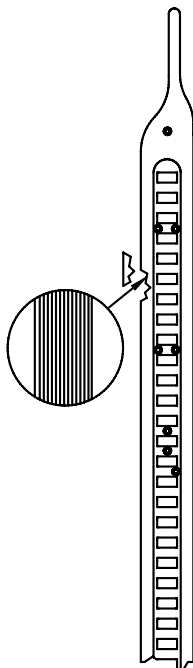

MODELLO AC2/S TP1 DESTRO MODEL AC2/S TP1 RIGHT

MATERIE PRIME
 RAW MATERIALS

 POLIESTERE/COTONE
 POLYESTER/COTTON,

ALT. TELAIO LOOM WIDTH	LUNG. NASTRO TAPE LENGTH	Fibercompositi CODICE/CODE
H. 1800 mm.	1900 mm.	10061900T1D
H. 1900 mm.	1900 mm.	10061900T1D
H. 2100 mm.	1900 mm.	10061900T1D
H. 2200 mm.	1900 mm.	10061900T1D
H. 2500 mm.	2450 mm.	10062450T1D
H. 2900 mm.	2450 mm.	10062450T1D
H. 3300 mm.	2450 mm.	10062450T1D
H. 3400 mm.	2450 mm.	10062450T1D
H. 3800 mm.	2700 mm.	10062700T1D
H. 4200 mm.	3100 mm.	10063100T1D
H. 4600 mm.	3400 mm.	10063400T1D

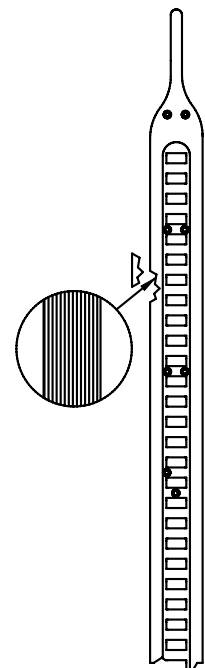

PARTI DI RICAMBIO PER TELAI SOMET INTERCAMBIABILI CON GLI ORIGINALI
SPARE PARTS FOR SOMET LOOMS INTERCHANGEABLE WITH THE ORIGINALS



COD.1025059A

PROTEZIONE PINZA MASTER IN ALLUMINIO
MASTER PLATE FOR ALUMINIUM GRIPPER

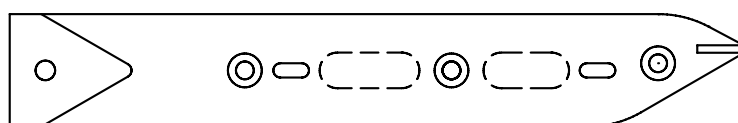

COD.1035L01B

PROTEZIONE PINZA TRAENTE ALLEGGERITA ALPHA GFG-PGA
RIGHT PLATE FOR ALPHA GFG-PGA GRIPPER



COD.1026017T

PROTEZIONE PER PINZA TRAENTE THEMA 11E
THEMA 11E PLATE TAKER

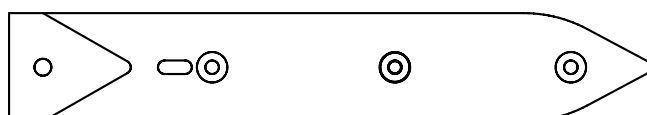

COD.1027047P

PROTEZIONE PER PINZA PORTANTE THEMA 11E
THEMA 11E PLATE BRINGER



COD.1028148P

PROTEZIONE PER PINZA CERAMICATA PORTANTE THEMA 11E
THEMA 11E PLATE BRINGER FOR CERAMIC GRIPPER

PARTI DI RICAMBIO PER TELAI SOMET INTERCambiabili CON GLI ORIGINALI
SPARE PARTS FOR SOMET LOOMS INTERCHANGEABLE WITH THE ORIGINALS

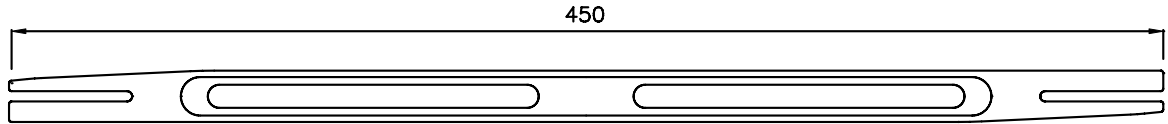

COD.1014100A

PATTINO APRIPIINZA PER THEMA 11
 GRIPPER OPENING SLIDING BLOCK FOR THEMA 11

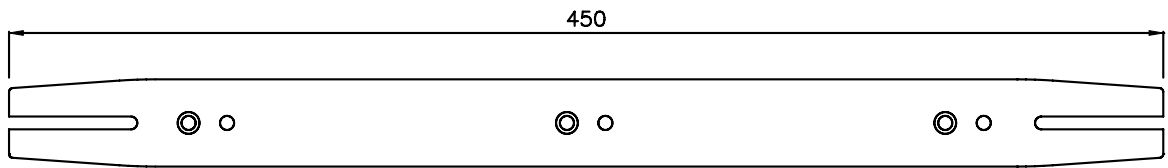

COD.1015118A

PATTINO APRIPIINZA PER THEMA 11E
 GRIPPER OPENING SLIDING BLOCK FOR THEMA 11E

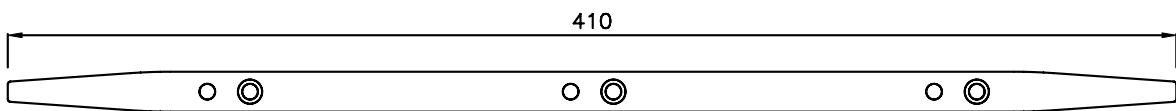

COD.1036135A

PATTINO APRIPIINZA PER THEMA11
 GRIPPER OPENING SLIDING BLOCK FOR THEMA11

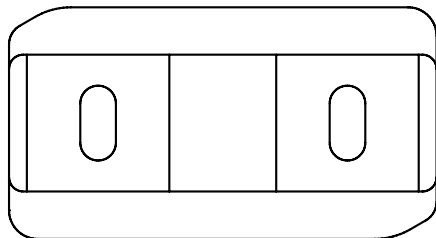

COD.1016083A

TASSELLO APRIPIINZA THEMA 11E /MFG
 OPENING PLATE THEMA 11E/MFG

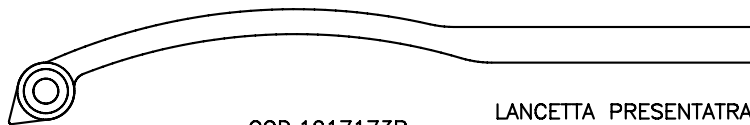

COD.1017173B

LANCETTA PRESENTATRAMA IN CARBONIO PER TRAME FINI
 THIN CARBON FINGER FOR WEFT SELECTORS



COD.1018175B

LANCETTA PRESENTATRAMA IN CARBONIO PER TRAME GROSSE
 THICK CARBON FINGER FOR WEFT SELECTORS

PARTI DI RICAMBIO PER TELAI SOMET INTERCAMBIABILI CON GLI ORIGINALI
SPARE PARTS FOR SOMET LOOMS INTERCHANGEABLE WITH THE ORIGINALS

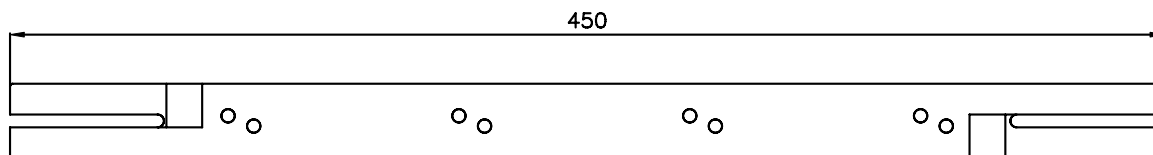

COD.1019B06A.1

PATTINO APRIPINZA PER ALPHA
GRIPPER OPENING SLIDING BLOCK FOR ALPHA

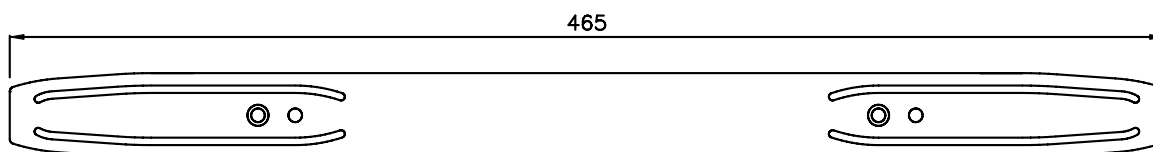

COD.1020B13A

PATTINO APRIPINZA TRAENTE PER ALPHA
RIGHT GRIPPER OPENING SLIDING BLOCK FOR ALPHA

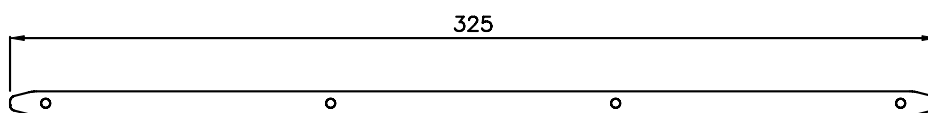

COD.1021429A

RISCONTRO TRAENTE PER ALPHA
RIGHT PLATE FOR ALPHA

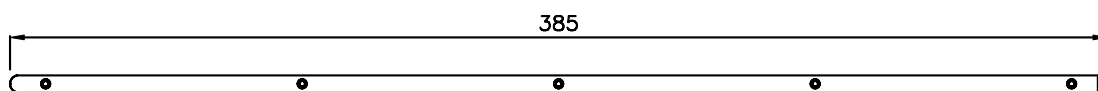

COD.1022428A

LISTELLO PER ALPHA
PLATE FOR ALPHA

PARTI DI RICAMBIO PER TELAI SOMET INTERCAMBIABILI CON GLI ORIGINALI
SPARE PARTS FOR SOMET LOOMS INTERCHANGEABLE WITH THE ORIGINALS

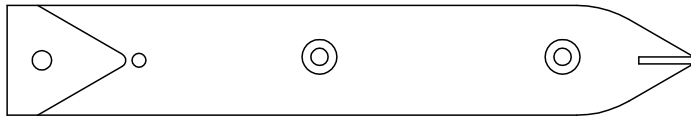

COD.1030211P

PROTEZIONE PER PINZA SURF PORTANTE
 LEFT PLATE FOR SURF GRIPPER

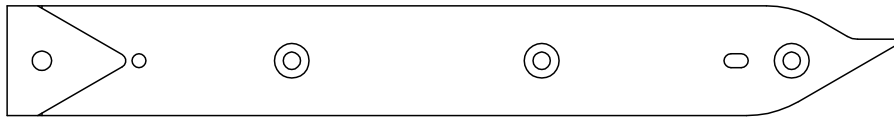

COD.1029223T

PROTEZIONE PER PINZA SURF TRAENTE
 RIGHT PLATE FOR SURF GRIPPER

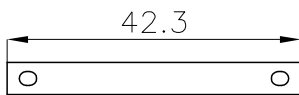

COD.1031004A

CINGHIETTA IN CARBONIO
 CARBON BELT

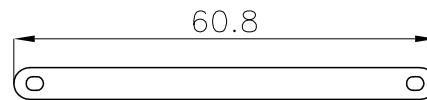

COD.1034141A

CINGHIETTA IN CARBONIO MFG
 CARBON BELT MFG

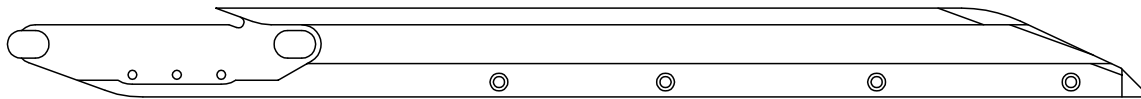

COD.1010178P

PUNTA INTERCAMBIABILE THEMA 11 EXCEL M.F.G. PORTANTE IN CARBONIO
 INTERCHANGEABLE TOP FOR THEMA 11 EXCEL M.F.G. BRINGER IN CARBON FIBRE

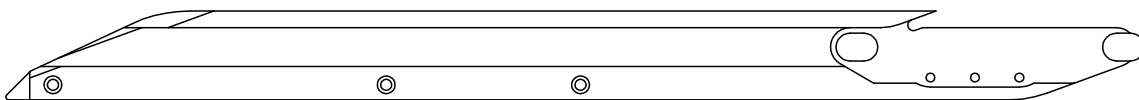

COD.1011179T

PUNTA INTERCAMBIABILE PER THEMA 11 EXCEL M.F.G. TRAENTE IN CARBONIO
 INTERCHANGEABLE TOP FOR THEMA 11 EXCEL M.F.G. TAKER IN CARBON FIBRE

NASTRI PER TELAI NUOVO PIGNONE INTERCAMBIABILI CON GLI ORIGINALI RAPIER TAPES FOR NUOVO PIGNONE LOOMS INTERCHANGEABLE WITH THE ORIGINALS

MODELLO TP600 MODEL TP600

MATERIE PRIME
 RAW MATERIALS

 TEFLON,
  CARBONIO,
  POLIESTERE
 TEFLON,
  CARBON FIBER,
  POLYESTER,

ALT. TELAIO LOOM WIDTH	LUNG. NASTRO TAPE LENGTH	Fibercompositi CODICE/CODE
H. 2000 mm.	2200 mm.	12062200TP6
H. 2200 mm.	2310 mm.	12062310TP6
H. 2400 mm.	2418 mm.	12062418TP6
H. 2600 mm.	2505 mm.	12062505TP6
H. 2900 mm.	2700 mm.	12062700TP6
H. 3300 mm.	2895 mm.	12062895TP6
H. 3600 mm.	3047 mm.	12063047TP6
H. 3800 mm.	3265 mm.	12063265TP6
H. 4400 mm.	3612 mm.	12063612TP6

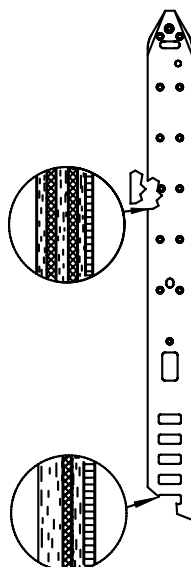

MODELLO TP600 PUNTA INTERCAMBIABILE MODEL TP600 INTERCHANGEABLE TOP

MATERIE PRIME
 RAW MATERIALS

 TEFLON,
  CARBONIO,
  POLIESTERE/COTONE
 TEFLON,
  CARBON FIBER,
  POLYESTER/COTTON

ALT. TELAIO LOOM WIDTH	LUNG. NASTRO TAPE LENGTH	Fibercompositi CODICE/CODE
H. 2000 mm.	2200 mm.	12072200TP6
H. 2200 mm.	2310 mm.	12072310TP6
H. 2400 mm.	2418 mm.	12072418TP6
H. 2600 mm.	2505 mm.	12072505TP6
H. 2900 mm.	2700 mm.	12072700TP6
H. 3300 mm.	2895 mm.	12072895TP6
H. 3600 mm.	3047 mm.	12073047TP6
H. 3800 mm.	3265 mm.	12073265TP6
H. 4400 mm.	3612 mm.	12073612TP6



MODELLO TP500 MODEL TP500

MATERIE PRIME
 RAW MATERIALS

 TEFLON,
  CARBONIO,
  POLIESTERE
 TEFLON,
  CARBON FIBER,
  POLYESTER,

ALT. TELAIO LOOM WIDTH	LUNG. NASTRO TAPE LENGTH	Fibercompositi CODICE/CODE
H. 2000 mm.	2200 mm.	12042200TP5
H. 2200 mm.	2310 mm.	12042310TP5
H. 2400 mm.	2418 mm.	12042418TP5
H. 2600 mm.	2505 mm.	12042505TP5
H. 2900 mm.	2700 mm.	12042700TP5
H. 3300 mm.	2895 mm.	12042895TP5
H. 3600 mm.	3047 mm.	12043047TP5
H. 3800 mm.	3265 mm.	12043265TP5
H. 4400 mm.	3612 mm.	12043612TP5

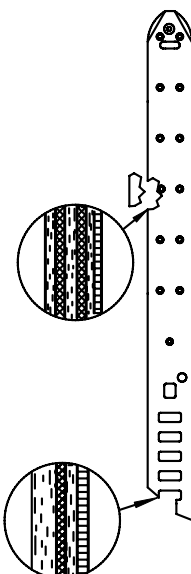

MODELLO TP500 PUNTA INTERCAMBIABILE MODEL TP500 INTERCHANGEABLE TOP

MATERIE PRIME
 RAW MATERIALS

 TEFLON,
  CARBONIO,
  POLIESTERE/COTONE
 TEFLON,
  CARBON FIBER,
  POLYESTER/COTTON



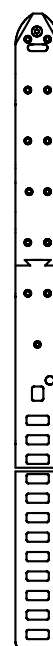



ALT. TELAIO LOOM WIDTH	LUNG. NASTRO TAPE LENGTH	Fibercompositi CODICE/CODE
H. 2000 mm.	2200 mm.	12052200TP5
H. 2200 mm.	2310 mm.	12052310TP5
H. 2400 mm.	2418 mm.	12052418TP5
H. 2600 mm.	2505 mm.	12052505TP5
H. 2900 mm.	2700 mm.	12052700TP5
H. 3300 mm.	2895 mm.	12052895TP5
H. 3600 mm.	3047 mm.	12053047TP5
H. 3800 mm.	3265 mm.	12053265TP5
H. 4400 mm.	3612 mm.	12053612TP5



NASTRI PER TELAI NUOVO PIGNONE INTERCAMBIABILI CON GLI ORIGINALI RAPIER TAPES FOR NUOVO PIGNONE LOOMS INTERCHANGEABLE WITH THE ORIGINALS

MODELLO TP400 MODEL TP400

MATERIE PRIME
RAW MATERIALS

 TEFLON,
  CARBONIO,
  POLIESTERE/KEVLAR.
 TEFLON,
  CARBON FIBER,
  POLYESTER/KEVLAR.

ALT. TELAIO LOOM WIDTH	LUNG. NASTRO TAPE LENGTH	Fibercompositi CODICE / CODE
H. 2000 mm.	1655 mm.	12031655TP4K
H. 2200 mm.	1752 mm.	12031752TP4K
H. 2400 mm.	1850 mm.	12031850TP4K
H. 2600 mm.	1948 mm.	12031948TP4K
H. 2900 mm.	2154 mm.	12032154TP4K
H. 3300 mm.	2348 mm.	12032348TP4K
H. 3600 mm.	2500 mm.	12032500TP4K
H. 4100 mm.	2748 mm.	12032748TP4K

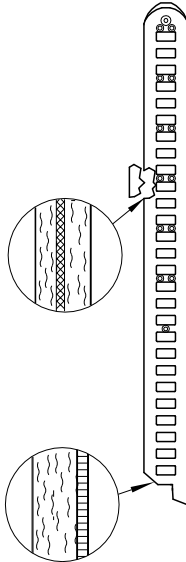

MODELLO TP400 SENZA KEVLAR MODEL TP400 WITHOUT KEVLAR

MATERIE PRIME
RAW MATERIALS





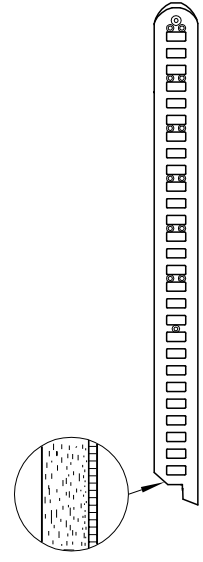

 TEFLON,
 POLIESTERE
 TEFLON,
  POLYESTER

ALT. TELAIO LOOM WIDTH	LUNG. NASTRO TAPE LENGTH	Fibercompositi CODICE / CODE
H. 2000 mm.	1655 mm.	12031655TP4
H. 2200 mm.	1752 mm.	12031752TP4
H. 2400 mm.	1850 mm.	12031850TP4
H. 2600 mm.	1948 mm.	12031948TP4
H. 2900 mm.	2154 mm.	12032154TP4
H. 3300 mm.	2348 mm.	12032348TP4
H. 3600 mm.	2500 mm.	12032500TP4
H. 4100 mm.	2748 mm.	12032748TP4



MODELLO TP300 MODEL TP300

MATERIE PRIME
RAW MATERIALS

 TEFLON,
  CARBONIO,
  POLIESTERE/KEVLAR.
 TEFLON,
  CARBON FIBER,
  POLYESTER/KEVLAR.

ALT. TELAIO LOOM WIDTH	LUNG. NASTRO TAPE LENGTH	Fibercompositi CODICE / CODE
H. 1900 mm.	1620 mm.	12011620TP3K
H. 2100 mm.	1720 mm.	12011720TP3K
H. 2300 mm.	1818 mm.	12011818TP3K
H. 2500 mm.	1916 mm.	12011916TP3K
H. 2900 mm.	2120 mm.	12012120TP3K
H. 3300 mm.	2316 mm.	12012316TP3K
H. 3600 mm.	2468 mm.	12012468TP3K
H. 4100 mm.	3000 mm.	12013000TP3K
H. 5500 mm.	3868 mm.	12013868TP3K

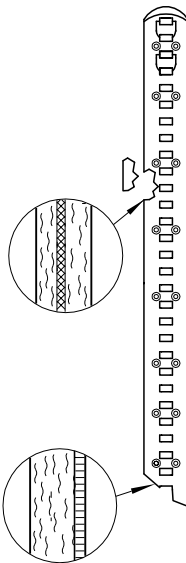

MODELLO TP300 SENZA KEVLAR MODEL TP300 WITHOUT KEVLAR

MATERIE PRIME
RAW MATERIALS

 TEFLON,
 POLIESTERE
 TEFLON,
  POLYESTER

ALT. TELAIO LOOM WIDTH	LUNG. NASTRO TAPE LENGTH	Fibercompositi CODICE / CODE
H. 1900 mm.	1620 mm.	12011620TP3
H. 2100 mm.	1720 mm.	12011720TP3
H. 2300 mm.	1818 mm.	12011818TP3
H. 2500 mm.	1916 mm.	12011916TP3
H. 2900 mm.	2120 mm.	12012120TP3
H. 3300 mm.	2316 mm.	12012316TP3
H. 3600 mm.	2468 mm.	12012468TP3
H. 4100 mm.	3000 mm.	12013000TP3
H. 5500 mm.	3868 mm.	12013868TP3

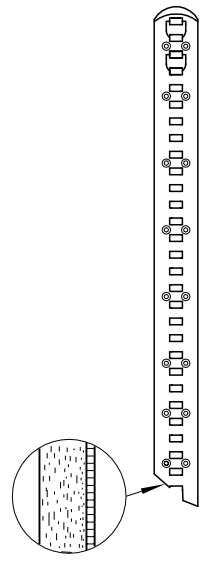

NASTRI PER TELAI NUOVO PIGNONE INTERCAMBIABILI CON GLI ORIGINALI RAPIER TAPES FOR NUOVO PIGNONE LOOMS INTERCHANGEABLE WITH THE ORIGINALS

MODELLO FAST MODEL FAST

MODELLO SULZER G6300 MODEL SULZER G6300

MATERIE PRIME
 RAW MATERIALS

- CARBONIO
 CARBON FIBER,

ALT. TELAIO LOOM WIDTH	LUNG. NASTRO TAPE LENGTH	Fibercompositi CODICE/ CODE
H. 1700 mm.	2510 mm.	12082510
H. 1900 mm.	2608 mm.	12082608
H. 2000 mm.	2650 mm.	12082650
H. 2200 mm.	2748 mm.	12082748
H. 2400 mm.	2846 mm.	12082846
H. 2600 mm.	2944 mm.	12082944
H. 2900 mm.	3150 mm.	12083150
H. 3200 mm.	3355 mm.	12083355
H. 3400 mm.	3450 mm.	12083450
H. 3600 mm.	3550mm.	12083550



MODELLO TP300 FINITO DUE PARTI MODEL TP300 FINISHED ON BOTH SIDES

- POLIESTERE/COTONE
 POLYESTER/COTTON

ALT. TELAIO LOOM WIDTH	LUNG. NASTRO TAPE LENGTH	Fibercompositi CODICE/ CODE
H. 1900 mm.	1900 mm.	12021900TP3F2
H. 2100 mm.	2010 mm.	12022010TP3F2
H. 2500 mm.	2213 mm.	12022213TP3F2
H. 2900 mm.	2620 mm.	12022620TP3F2
H. 3300 mm.	2620 mm.	12022620TP3F2
H. 3600 mm.	2766 mm.	12022766TP3F2
H. 4100 mm.	3016 mm.	12023015TP3F2

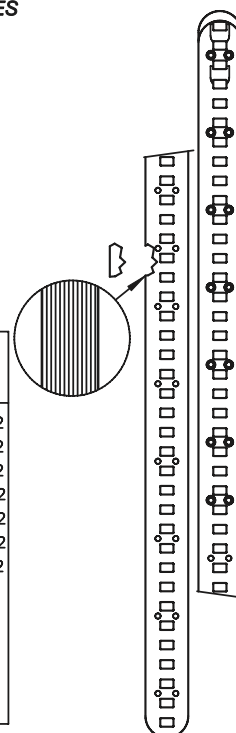

MODELLO GS900 MODEL GS900

MATERIE PRIME
 RAW MATERIALS

- CARBONIO
 CARBON FIBER,

ALT. TELAIO LOOM WIDTH	LUNG. NASTRO TAPE LENGTH	Fibercompositi CODICE/ CODE
H. 1400 mm.	2382 mm.	50092382
H. 1700 mm.	2532 mm.	50092532
H. 1900 mm.	2630 mm.	50092630
H. 2000 mm.	2672 mm.	50092672
H. 2200 mm.	2770 mm.	50092770
H. 2300 mm.	2822 mm.	50092822
H. 2400 mm.	2868 mm.	50092868
H. 2600 mm.	2966 mm.	50092966
H. 2900 mm.	3172 mm.	50093172
H. 3200 mm.	3377 mm.	50093377
H. 3400 mm.	3472 mm.	50093472
H. 3600 mm.	3572 mm.	50093572

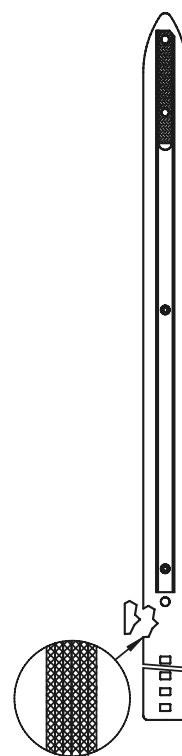

RUOTA DENTATA N.P.FAST/GS900 N.P. FAST/GS900 DRIVE WHEEL

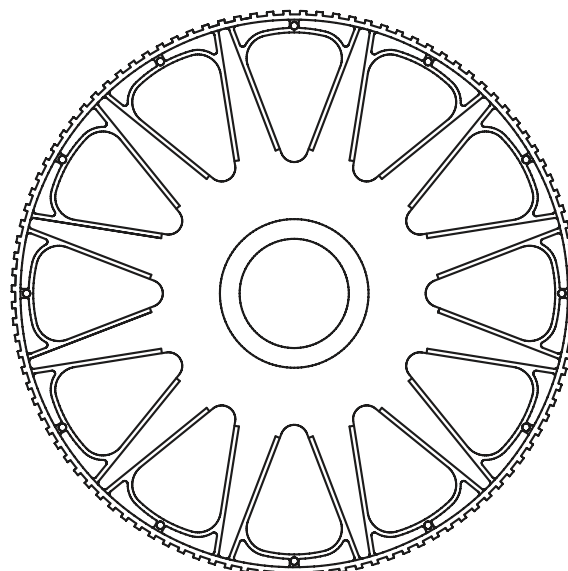

PARTI DI RICAMBIO PER TELAI NUOVO PIGNONE INTERCAMBIABILI CON GLI ORIGINALI
SPARE PARTS FOR NUOVO PIGNONE LOOMS INTERCHANGEABLE WITH THE ORIGINALS



COD.120953941

LISTA SOTTO NASTRO PER TP500
 UNDER TAPE PLATE FOR TP500

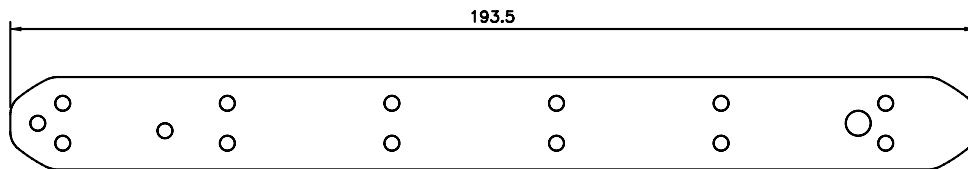

COD.121053944

LISTA SOTTO NASTRO PER TP600
 UNDER TAPE PLATE FOR TP600

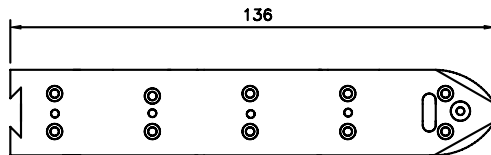

COD.121153956

PUNTA INTERCAMBIABILE PER NASTRO TP500
 INTERCHANGEABLE TOP FOR TAPE TP500

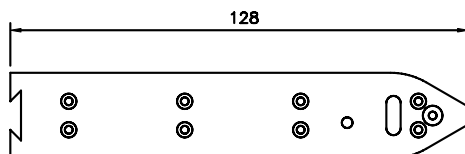

COD.121253955

PUNTA INTERCAMBIABILE PER NASTRO TP600
 INTERCHANGEABLE TOP FOR TAPE TP600

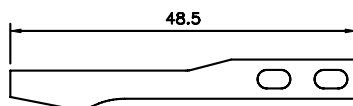

COD.1213TP6

PINZA TRAMA TP600
 WEFT GRIPPER TP600

PARTI DI RICAMBIO PER TELAI NUOVO PIGNONE INTERCambiabili CON GLI ORIGINALI
SPARE PARTS FOR NUOVO PIGNONE LOOMS INTERCHANGEABLE WITH THE ORIGINALS

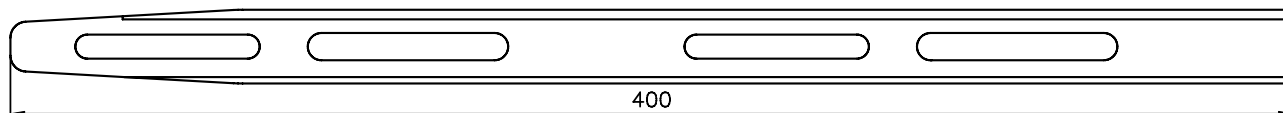

COD.5017

LISTA SGANCIA TRAMA GS900
 WEFT RELEASE GS900

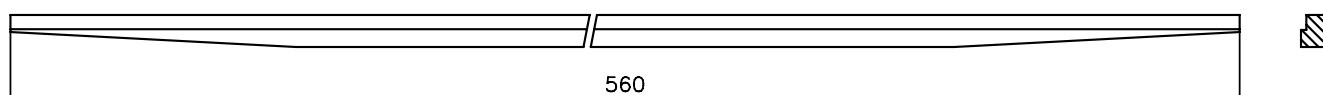

COD.5011889

LISTA SGANCIA TRAMA FAST
 STRIP WEFT RELEASE FOR FAST

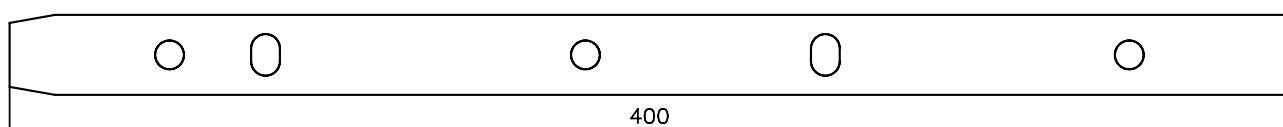

COD.5012906

LISTA APPOGGIO PINZA TRAZIONE
 STRIP SUPPORT RH GRIPPER

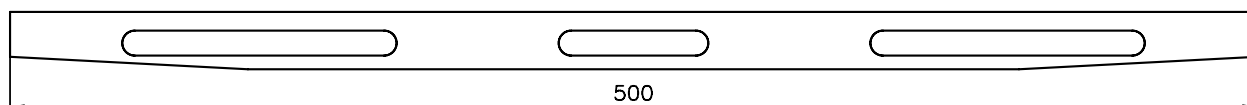

COD.5013887

LISTA SGANCIA TRAMA
 WEFT RELEASE PAD

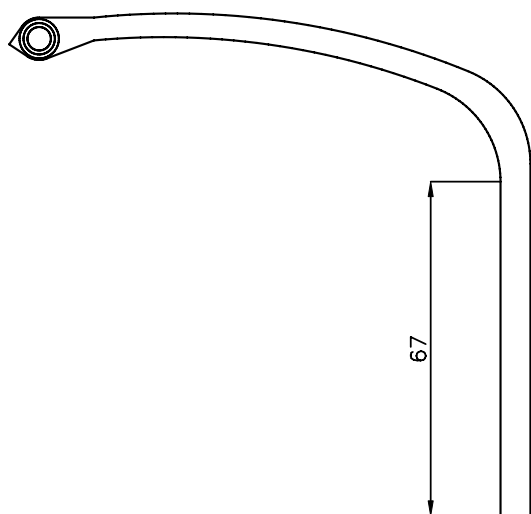

COD.1215105 LANCETTA PRESENTATRAMA IN CARBONIO
 CARBON FINGER FOR WEFT SELECTOR

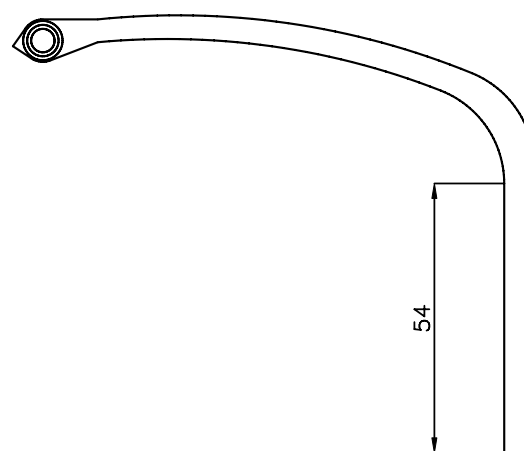

COD.1214106 LANCETTA PRESENTATRAMA IN CARBONIO
 CARBON FINGER FOR WEFT SELECTOR

NASTRI PER TELAI PICANOL INTERCAMBIABILI CON GLI ORIGINALI
RAPIER TAPES FOR PICANOL LOOMS INTERCHANGEABLE WITH THE ORIGINALS



NASTRO GAMMAX SINISTRO
 GAMMAX RAPIER TAPE LEFT

ALT. TELAIO LOOM WIDTH	LUNG. NASTRO TAPE LENGTH	Fibercompositi CODICE /CODE
190	1808	13191808S

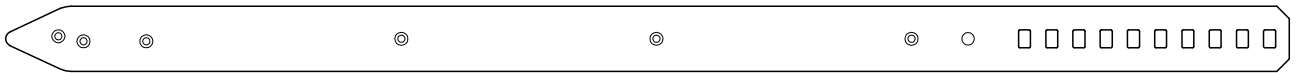

210	2664	13192664S
220	2707	13192707S
230	2761	13192761S
250	2859	13192859S
300	3108	13193108S
320	3206	13193206S
340	3325	13193325S



NASTRO GAMMAX DESTRO
 GAMMAX RAPIER TAPE RIGHT

ALT. TELAIO LOOM WIDTH	LUNG. NASTRO TAPE LENGTH	Fibercompositi CODICE /CODE
190	1796	13191796D



210	2641	13192641D
220	2685	13192685D
230	2739	13192739D
250	2836	13192836D
300	3086	13193086D
320	3194	13193194D
340	3302	13193302D



NASTRO GAMMAX DESTRO
 GAMMAX RAPIER TAPE RIGHT

ALT. TELAIO LOOM WIDTH	LUNG. NASTRO TAPE LENGTH	Fibercompositi CODICE /CODE
190	1846	13191846D









220	2735	13192735D
250	2887	13192887D
300	3136	13193136D
340	3352	13193352D

NASTRI PER TELAI PICANOL INTERCAMBIABILI CON GLI ORIGINALI RAPIER TAPES FOR PICANOL LOOMS INTERCHANGEABLE WITH THE ORIGINALS

MODELLO GAMMAX SINISTRO MODEL GAMMAX LEFT

MATERIE PRIME
RAW MATERIALS





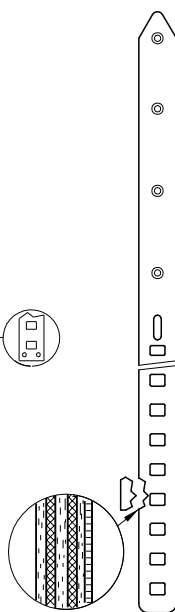

 TEFLON,  CARBONIO,  POLIESTERE
 TEFLON,  CARBON FIBER,  POLYESTER,

ALT. TELAIO LOOM WIDTH	LUNG. NASTRO TAPE LENGTH	Fibercompositi CODICE/ CODE
H. 1900 mm.	1704 mm.	13101704S
H. 2100 mm.	2529 mm	13102529S
H. 2200 mm.	2580 mm	13102580S
H. 2300 mm.	2631 mm	13102631S
H. 2500 mm.	2733 mm	13102733S
H. 3000 mm.	2974 mm	13102974S
H. 3200 mm.	3075 mm	13103075S
H. 3400 mm.	3177 mm	13103177S
H. 3600 mm.	3278 mm	13103278S
H. 3800 mm.	3380 mm	13103380S



MODELLO GAMMA DESTRO MODEL GAMMA RIGHT

MATERIE PRIME
RAW MATERIALS





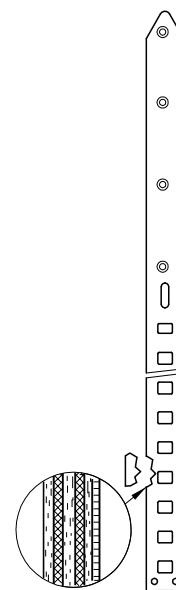

 TEFLON,  CARBONIO,  POLIESTERE
 TEFLON,  CARBON FIBER,  POLYESTER,

ALT. TELAIO LOOM WIDTH	LUNG. NASTRO TAPE LENGTH	Fibercompositi CODICE/ CODE
H. 1900 mm.	1728 mm.	13101728D



MODELLO GAMMAX DESTRO MODEL GAMMAX RIGHT

MATERIE PRIME
RAW MATERIALS

 TEFLON,  CARBONIO,  POLIESTERE
 TEFLON,  CARBON FIBER,  POLYESTER,

ALT. TELAIO LOOM WIDTH	LUNG. NASTRO TAPE LENGTH	Fibercompositi CODICE/ CODE
H. 1900 mm.	1743 mm.	13111743D
H. 2100 mm.	2558 mm	13112558D
H. 2200 mm.	2609 mm	13112609D
H. 2300 mm.	2660 mm	13112660D
H. 2500 mm.	2761 mm	13112761D
H. 3000 mm.	3003 mm	13113003D
H. 3200 mm.	3130mm	13113130D
H. 3400 mm.	3219 mm	13113219D
H. 3600 mm.	3307 mm	13113307D
H. 3800 mm.	3396 mm	13113396D

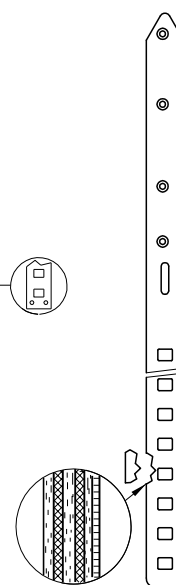

NASTRI PER TELAI PICANOL INTERCambiabili CON GLI ORIGINALI RAPIER TAPES FOR PICANOL LOOMS INTERCHANGEABLE WITH THE ORIGINALS

MODELLO GAMMA SINISTRO MODEL GAMMA LEFT

MATERIE PRIME
 RAW MATERIALS

TEFLON, CARBONIO POLIESTERE
 TEFLON, CARBON FIBER, POLYESTER,

ALT. TELAIO LOOM WIDTH	LUNG. NASTRO TAPE LENGTH	Fibercompositi CODICE/COE
H. 1900 mm.	1732 mm.	13091732S
H. 2200 mm.	2612 mm.	13092612S
H. 2500 mm.	2764 mm.	13092764S
H. 3000 mm.	3006 mm.	13093006S
H. 3400 mm.	3209 mm.	13093209S
H. 3800 mm.	3412 mm.	13093412S

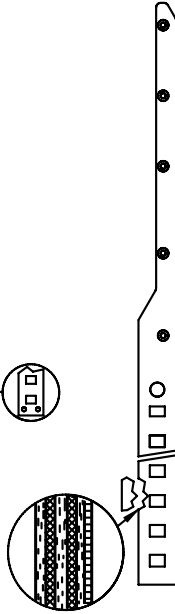

MODELLO GAMMA DESTRO MODEL GAMMA RIGHT

MATERIE PRIME
 RAW MATERIALS

TEFLON, CARBONIO POLIESTERE
 TEFLON, CARBON FIBER, POLYESTER,

ALT. TELAIO LOOM WIDTH	LUNG. NASTRO TAPE LENGTH	Fibercompositi CODICE/COE
H. 1900 mm.	1769 mm.	13091769D
H. 2200 mm.	2649 mm.	13092649D
H. 2500 mm.	2802 mm.	13092802D
H. 3000 mm.	3043 mm.	13093043D
H. 3400 mm.	3259 mm.	13093259D
H. 3800 mm.	3437 mm.	13093437D

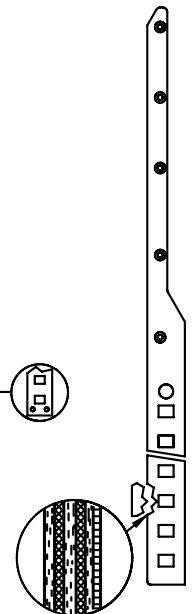

NASTRI PER TELAI PICANOL INTERCambiabili CON GLI ORIGINALI RAPIER TAPES FOR PICANOL LOOMS INTERCHANGEABLE WITH THE ORIGINALS

MODELLO GTM AS 1 SERIE DESTRO 2 STRATI CARBONIO
MODEL GTM AS 1 SERIES RIGHT 2 CARBON STRIP

MATERIE PRIME
 RAW MATERIALS

 TEFLON,
  CARBONIO,
  POLIESTERE
 TEFLON,
  CARBON FIBER,
  POLYESTER,

ALT. TELAIO LOOM WIDTH	LUNG. NASTRO TAPE LENGTH	Fibercompositi CODICE/CODE
H. 190	2193 mm.	13032193C2D
H. 220-240	2612 mm.	13032612C2D
H. 280	2943 mm.	13032943C2D

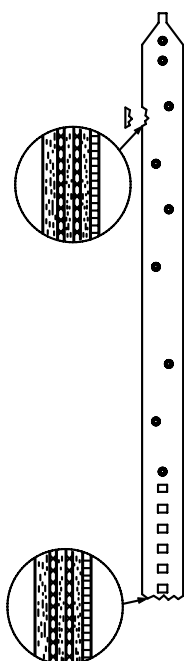

MODELLO GTM AS SINISTRO
MODEL GTM AS LEFT

MATERIE PRIME
 RAW MATERIALS

 TEFLON,
  CARBONIO,
  POLIESTERE
 TEFLON,
  CARBON FIBER,
  POLYESTER,

ALT. TELAIO LOOM WIDTH	LUNG. NASTRO TAPE LENGTH	Fibercompositi CODICE/CODE
H. 190	2155 mm.	13042155C2S
H. 190	2218 mm.	13042218C1S
H. 220-240	2574 mm.	13042574C2S
H. 280	2904 mm.	13042904C2S

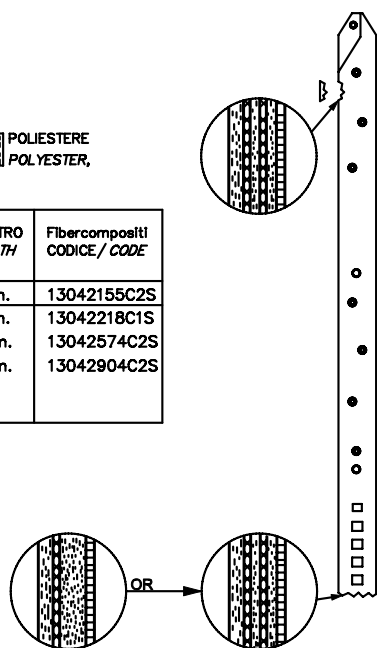

MODELLO GTM AS DESTRO
MODEL GTM AS RIGHT

MATERIE PRIME
 RAW MATERIALS

 TEFLON,
  CARBONIO,
  POLIESTERE
 TEFLON,
  CARBON FIBER,
  POLYESTER,

ALT. TELAIO LOOM WIDTH	LUNG. NASTRO TAPE LENGTH	Fibercompositi CODICE/CODE
H. 190	2269 mm.	13042269C1D
H. 220-240	2637 mm.	13042637C2D
H. 280	2967 mm.	13042967C2D

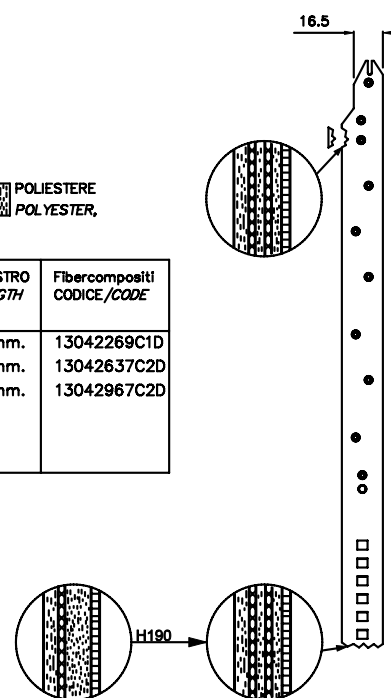

NASTRI PER TELAI PICANOL INTERCAMBIABILI CON GLI ORIGINALI RAPIER TAPES FOR PICANOL LOOMS INTERCHANGEABLE WITH THE ORIGINALS

MODELLO GTM SINISTRO CON MAGNETE MODEL GTM LEFT WITH MAGNET

MATERIE PRIME
RAW MATERIALS

TEFLON,
TEFLON,

POLIESTERE
POLYESTER,

ALT. TELAIO LOOM WIDTH	LUNG. NASTRO TAPE LENGTH	Fibercompositi CODICE/ CODE
H. 1900 mm.	2173 mm.	13012173NMS
H. 2400 mm.	2631 mm.	13012631NMS
H. 2800 mm.	2961 mm.	13012961NMS

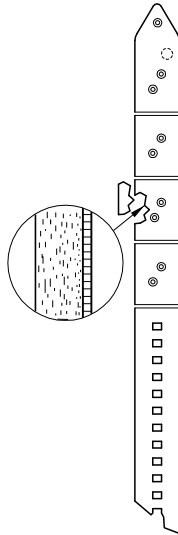

MODELLO GTM DESTRO CON MAGNETE MODEL GTM RIGHT WITH MAGNET

MATERIE PRIME
RAW MATERIALS

TEFLON,
TEFLON,

POLIESTERE
POLYESTER,

ALT. TELAIO LOOM WIDTH	LUNG. NASTRO TAPE LENGTH	Fibercompositi CODICE/ CODE
H. 1900 mm.	2161 mm.	13012161NMD
H. 2400 mm.	2631 mm.	13012631NMD
H. 2800 mm.	2948 mm.	13012948NMD

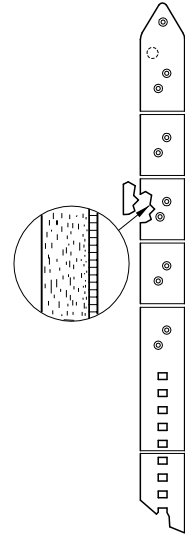

MODELLO GTM SINISTRO SENZA MAGNETE MODEL GTM LEFT WITHOUT MAGNET

MATERIE PRIME
RAW MATERIALS

TEFLON,
TEFLON,

POLIESTERE
POLYESTER,

ALT. TELAIO LOOM WIDTH	LUNG. NASTRO TAPE LENGTH	Fibercompositi CODICE/ CODE
H. 1900 mm.	2173 mm.	13012173NS
H. 2400 mm.	2631 mm.	13012631NS
H. 2800 mm.	2961 mm.	13012961NS

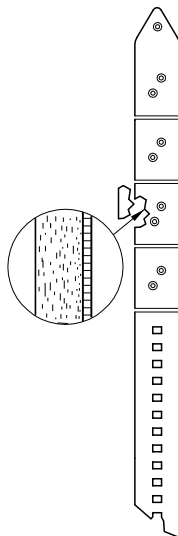

MODELLO GTM DESTRO SENZA MAGNETE MODEL GTM RIGHT WITHOUT MAGNET

MATERIE PRIME
RAW MATERIALS

TEFLON,
TEFLON,

POLIESTERE
POLYESTER,

ALT. TELAIO LOOM WIDTH	LUNG. NASTRO TAPE LENGTH	Fibercompositi CODICE/ CODE
H. 1900 mm.	2161 mm.	13012161ND
H. 2400 mm.	2631 mm.	13012631ND
H. 2800 mm.	2948 mm.	13012948ND

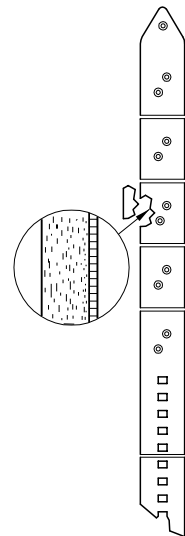

NASTRI PER TELAI PICANOL INTERCambiabili CON GLI ORIGINALI RAPIER TAPES FOR PICANOL LOOMS INTERCHANGEABLE WITH THE ORIGINALS

MODELLO GTM SINISTRO C1 CON MAGNETE MODEL GTM LEFT C1 WITH MAGNET

**MATERIE PRIME
 RAW MATERIALS**

TEFLON, CARBONIO POLIESTERE
 TEFLON, CARBON FIBER, POLYESTER,

ALT. TELAIO LOOM WIDTH	LUNG. NASTRO TAPE LENGTH	Fibercompositi CODICE/ CODE
H. 1900 mm.	2173 mm.	13012173C1MS
H. 2400 mm.	2631 mm.	13012631C1MS
H. 2800 mm.	2961 mm.	13012961C1MS

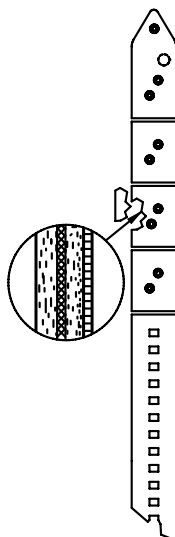

MODELLO GTM DESTRO C1 CON MAGNETE MODEL GTM RIGHT C1 WITH MAGNET

**MATERIE PRIME
 RAW MATERIALS**

TEFLON, CARBONIO POLIESTERE
 TEFLON, CARBON FIBER, POLYESTER,

ALT. TELAIO LOOM WIDTH	LUNG. NASTRO TAPE LENGTH	Fibercompositi CODICE/ CODE
H. 1900 mm.	2161 mm.	13012161C1MD
H. 2400 mm.	2631 mm.	13012631C1MD
H. 2800 mm.	2948 mm.	13012948C1MD

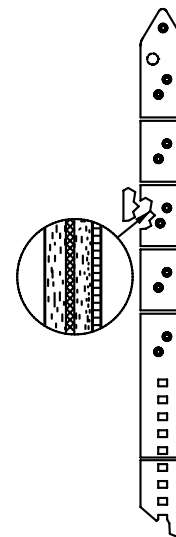

MODELLO GTM SINISTRO SENZA MAGNETE C1 MODEL GTM LEFT WITHOUT MAGNET C1

**MATERIE PRIME
 RAW MATERIALS**

TEFLON, CARBONIO POLIESTERE
 TEFLON, CARBON FIBER, POLYESTER,

ALT. TELAIO LOOM WIDTH	LUNG. NASTRO TAPE LENGTH	Fibercompositi CODICE/ CODE
H. 1900 mm.	2173 mm.	13012173C1S
H. 2400 mm.	2631 mm.	13012631C1S
H. 2800 mm.	2961 mm.	13012961C1S

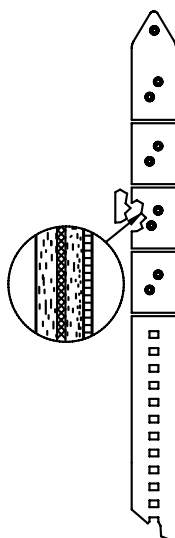

MODELLO GTM DESTRO SENZA MAGNETE C1 MODEL GTM RIGHT WITHOUT MAGNET C1

**MATERIE PRIME
 RAW MATERIALS**

TEFLON, CARBONIO POLIESTERE
 TEFLON, CARBON FIBER, POLYESTER,

ALT. TELAIO LOOM WIDTH	LUNG. NASTRO TAPE LENGTH	Fibercompositi CODICE/ CODE
H. 1900 mm.	2161 mm.	13012161C1D
H. 2400 mm.	2631 mm.	13012631C1D
H. 2800 mm.	2948 mm.	13012948C1D

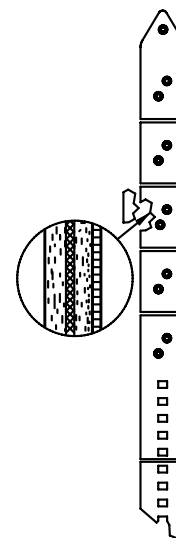

NASTRI PER TELAI PICANOL INTERCambiabili CON GLI ORIGINALI RAPIER TAPES FOR PICANOL LOOMS INTERCHANGEABLE WITH THE ORIGINALS

MODELLO GTM-A CON FORI AGGANCIAMENTO PINZA GTM AS
MODEL GTM -A GRIPPER HOLES FOR THE GTM AS

MATERIE PRIME
RAW MATERIALS

TEFLON, CARBONIO, POLIESTERE
 TEFLON, CARBON FIBER, POLYESTER,

ALT. TELAIO LOOM WIDTH	LUNG. NASTRO TAPE LENGTH	Fibercompositi CODICE/CODE
H. 1900 mm.	2215 mm.	13022215
H. 2200 mm.	2695 mm.	13022695
H. 2400 mm.	2695 mm.	13022695
H. 2800 mm.	3025 mm.	13023025

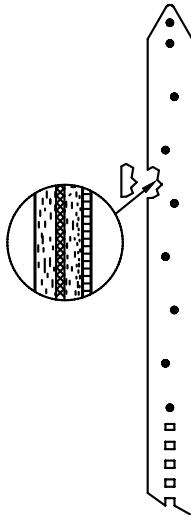

MODELLO PGW 10 FORI
MODEL PGW 10 HOLES

MATERIE PRIME
RAW MATERIALS

POLIESTERE
 POLYESTER,

ALT. TELAIO LOOM WIDTH	LUNG. NASTRO TAPE LENGTH	Fibercompositi CODICE/CODE
H. 2000 mm.	1478.4 mm.	13061478
H. 2450 mm.	1707.0 mm.	13061707
H. 2820 mm.	1897.5 mm.	13061897
H. 3000 mm.	1986.4 mm.	13061986

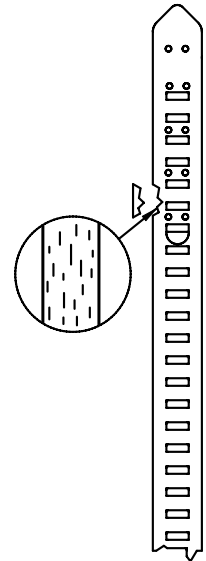

MODELLO PGW 12 FORI
MODEL PGW 12 HOLES

MATERIE PRIME
RAW MATERIALS

POLIESTERE
 POLYESTER,

ALT. TELAIO LOOM WIDTH	LUNG. NASTRO TAPE LENGTH	Fibercompositi CODICE/CODE
H. 1900 mm.	1519.4 mm.	13071519
H. 2450 mm.	1748.0 mm.	13071748
H. 2820 mm.	1938.5 mm.	13071938
H. 3000 mm.	2021.4 mm.	13072021
H. 3500 mm.	2281.9 mm.	13072281

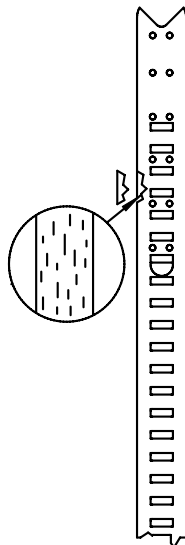

MODELLO PGW 18 FORI
MODEL PGW 18 HOLES

MATERIE PRIME
RAW MATERIALS

POLIESTERE
 POLYESTER,

ALT. TELAIO LOOM WIDTH	LUNG. NASTRO TAPE LENGTH	Fibercompositi CODICE/CODE
H. 1900 mm.	1519.4 mm.	13081519
H. 2450 mm.	1748.0 mm.	13081748
H. 2820 mm.	1938.5 mm.	13081938
H. 3000 mm.	2021.4 mm.	13082021
H. 3500 mm.	2281.9 mm.	13082281

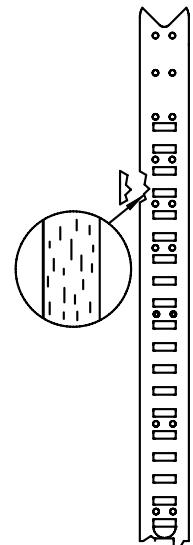

PARTI DI RICAMBIO PER TELAI PICANOL INTERCambiabili CON GLI ORIGINALI
SPARE PARTS FOR PICANOL LOOMS INTERCHANGEABLE WITH THE ORIGINALS

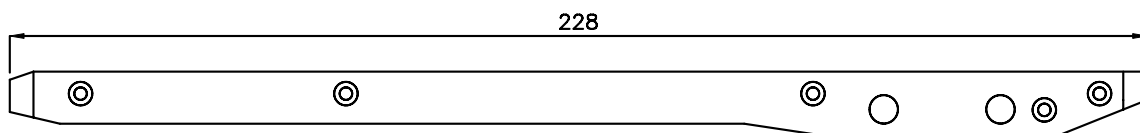

COD. 132384468D

LISTELLO GTM DESTRO
 RIGHT GTM PLATE

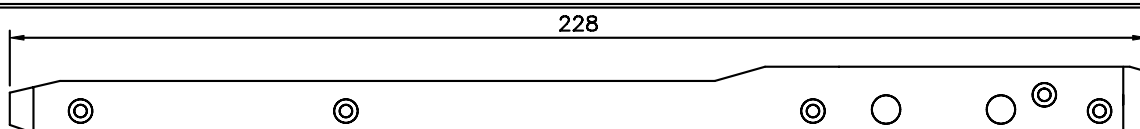

COD. 131284471S

LISTELLO GTM SINISTRO
 LEFT GTM PLATE

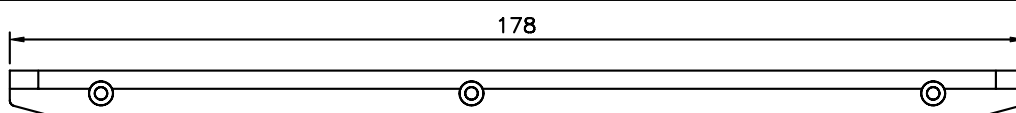

COD. 1313B88420

LISTELLO
 PLATE

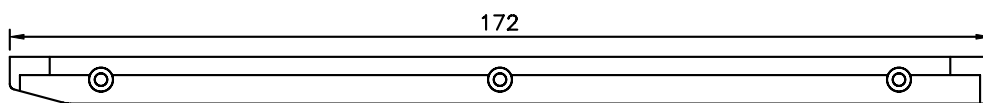

COD. 1314B88419

LISTELLO
 PLATE

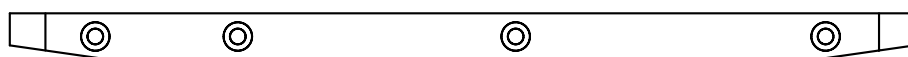

COD. 1315B53051

LISTELLO
 PLATE

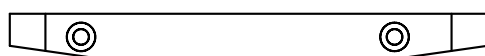

COD. 1316B54121

LISTELLO
 PLATE

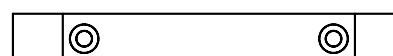

COD. 1317B54255

LISTELLO
 PLATE

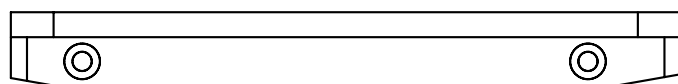

COD. 1321B54794

LISTELLO
 PLATE

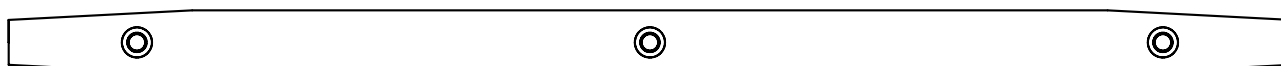

COD. 1322BA218520

APRIPINZA GAMMAX BA218520 IN POLIESTERE
 GAMMAX OPENER BA218520 IN POLYESTER

NASTRI PER TELAI SULZER RÜTI INTERCAMBIABILI CON GLI ORIGINALI
RAPIER TAPES FOR SULZER RÜTI LOOMS INTERCHANGEABLE WITH THE ORIGINALS

MODELLO G6100
MODEL G6100

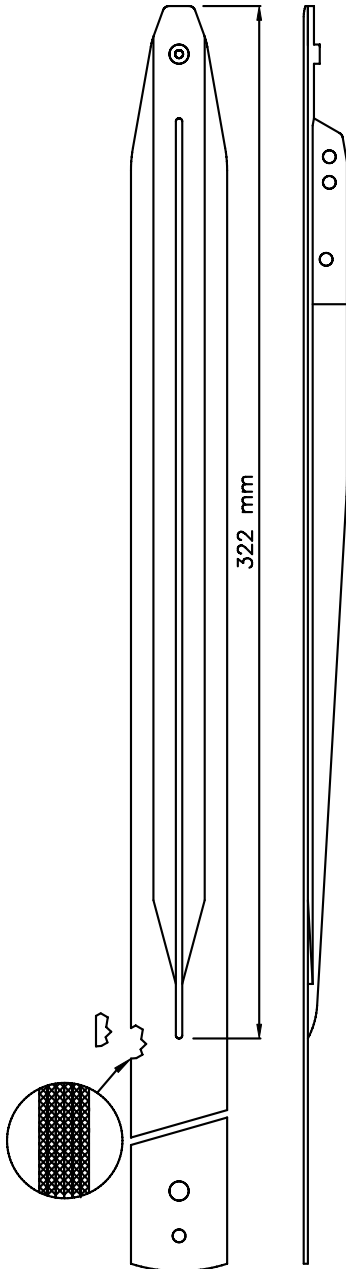

MATERIE PRIME
RAW MATERIALS

CARBONIO
 CARBON FIBER.

ALT. TELAIO LOOM WIDTH	LUNG. NASTRO TAPE LENGTH	Fibercompositi CODICE / CODE
140-160	1663 mm	24021663C
170-190	1813 mm	24021813C
200-220	1963 mm	24021963C
230-250	2113 mm	24022113C
260-280	2263 mm	24022263C
290	2363 mm	24022363C

MODELLO G6100
MODEL G6100

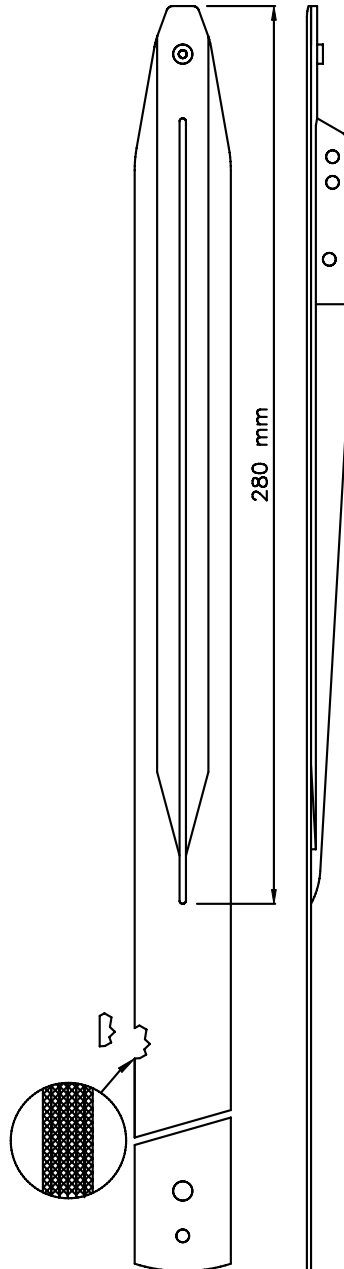

MATERIE PRIME
RAW MATERIALS

CARBONIO
 CARBON FIBER.

ALT. TELAIO LOOM WIDTH	LUNG. NASTRO TAPE LENGTH	Fibercompositi CODICE / CODE
140-180	1692 mm	24031692C
190-210	1842 mm	24031842C
220-250	2042 mm	24032042C
260-290	2242 mm	24032242C

MODELLO G6100
MODEL G6100

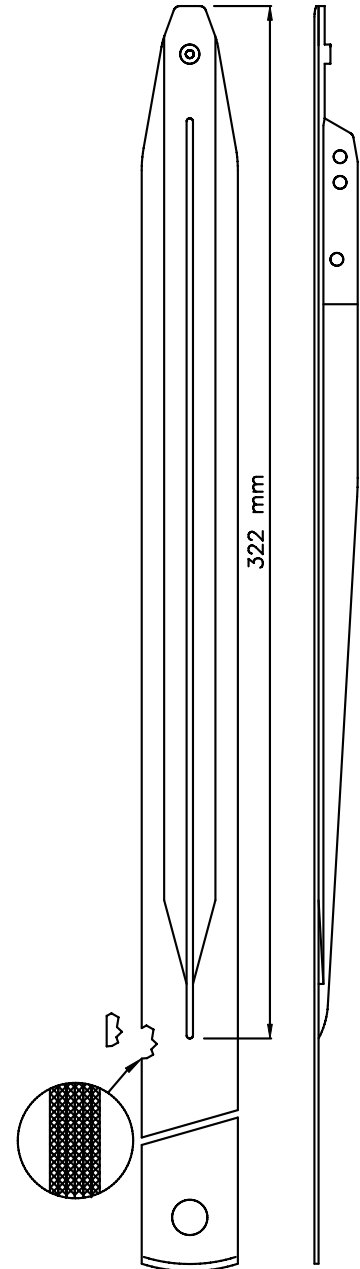

MATERIE PRIME
RAW MATERIALS

CARBONIO
 CARBON FIBER.

ALT. TELAIO LOOM WIDTH	LUNG. NASTRO TAPE LENGTH	Fibercompositi CODICE / CODE
140-160	1638 mm	24041638C
170-190	1756 mm	24041756C
200-220	1906 mm	24041906C
230-250	2071 mm	24042071C
260-280	2228 mm	24042228C

NASTRI PER TELAI SULZER RÜTI INTERCAMBIABILI CON GLI ORIGINALI
 RAPIER TAPES FOR SULZER RÜTI LOOMS INTERCHANGEABLE WITH THE ORIGINALS

MODELLO F2001 DX
 MODEL F2001 RIGHT

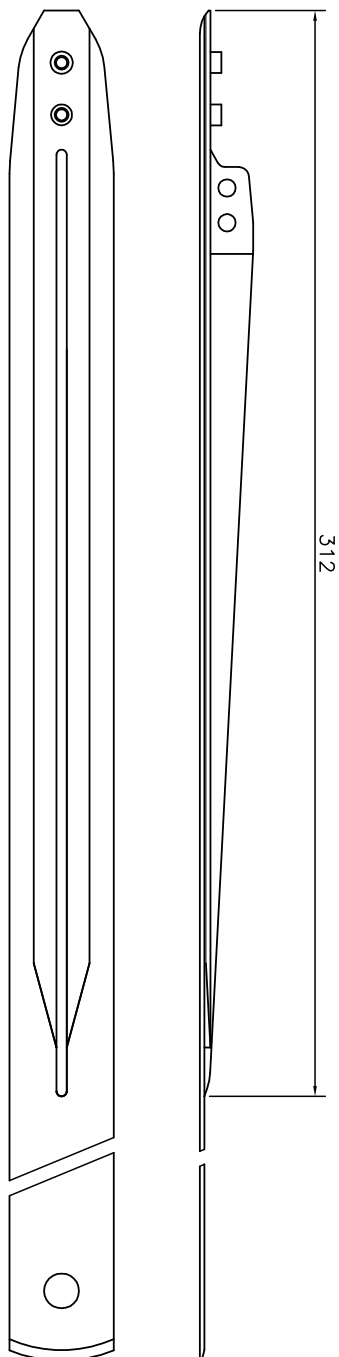

MODELLO F2001 SX
 MODEL F2001 LEFT

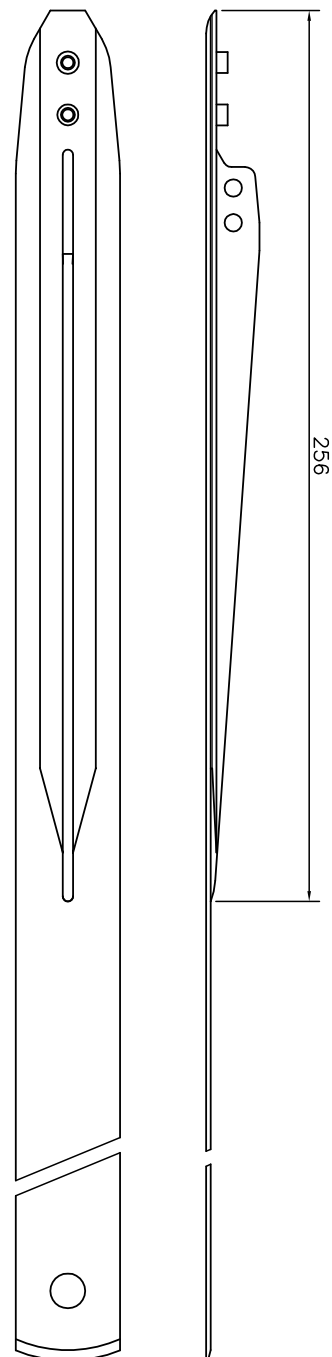

ALT. TELAIO LOOM WIDTH	LUNG. NASTRO TAPE LENGTH	Fibercompositi CODICE/ CODE	Variante Variant		ALT. TELAIO LOOM WIDTH	LUNG. NASTRO TAPE LENGTH	Fibercompositi CODICE/ CODE	Variante Variant	
			C	K				C	K
140-160	1592 mm	24111592R			140-160	1542 mm	24111542L		
170-190	1675 mm	24111675R	In carbonio spessore 1.3 In carbon thickness 1.3 In kevlar spessore 1.6 In kevlar thickness 1.6		170-190	1660 mm	24111660L	In carbonio spessore 1.3 In carbon thickness 1.3 In kevlar spessore 1.6 In kevlar thickness 1.6	
170-190	1710 mm	24111710R			200-220	1810 mm	24111810L		
200-220	1860 mm	24111860R			230-250	1975 mm	24111975L		
230-250	2025 mm	24112025R			260-280	2132 mm	24112132L		
260-280	2182 mm	24112182R			290	2179 mm	24112179L		

NASTRI PER TELAI SULZER RÜTI INTERCAMBIABILI CON GLI ORIGINALI
 RAPIER TAPES FOR SULZER RÜTI LOOMS INTERCHANGEABLE WITH THE ORIGINALS

MODELLO F2001 DX
 MODEL F2001 RIGHT

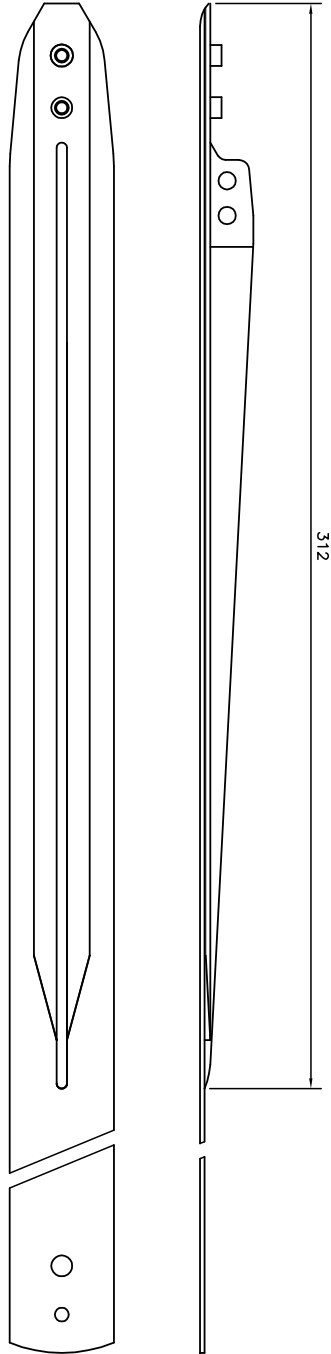

MODELLO F2001 SX
 MODEL F2001 LEFT

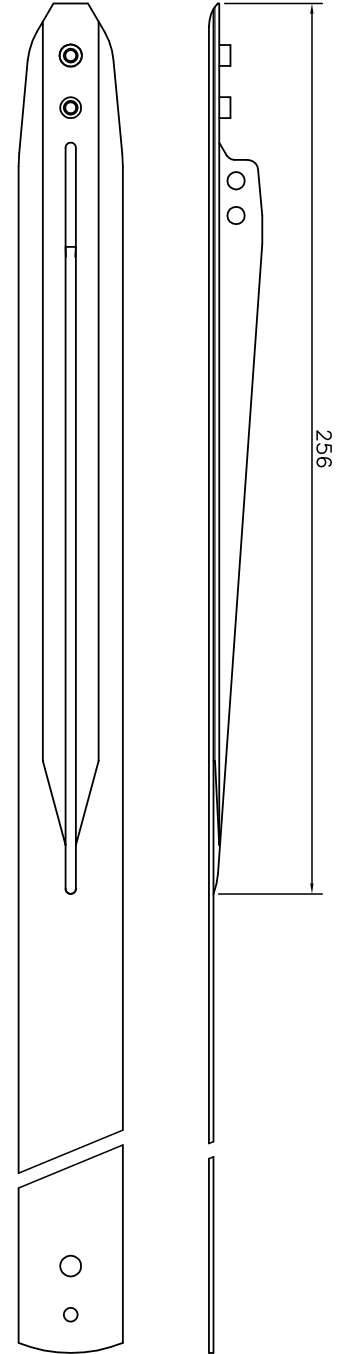

ALT. TELAIO LOOM WIDTH	LUNG. NASTRO TAPE LENGTH	Fibercompositi CODICE/ CODE	Variante Variant		ALT. TELAIO LOOM WIDTH	LUNG. NASTRO TAPE LENGTH	Fibercompositi CODICE/ CODE	Variante Variant	
			C	K				C	K
140-160	1619 mm	24121619R	C	K	140-160	1632 mm	24121632L	C	K
170-190	1769 mm	24121769R	In carbonio spessore 1,3 In carbon thickness 1,3 In kevlar spessore 1,6 In kevlar thickness 1,6		170-190	1782 mm	24121782L	In carbonio spessore 1,3 In carbon thickness 1,3 In kevlar spessore 1,6 In kevlar thickness 1,6	
200-220	1919 mm	24121919R			200-220	1932 mm	24121932L		
230-250	2069 mm	24122069R			230-250	2082 mm	24122082L		
260-280	2219 mm	24122219R			260-280	2232 mm	24122232L		
290	2269 mm	24122269R			290	2282 mm	24122282L		

NASTRI PER TELAI SULZER RÜTI INTERCAMBIABILI CON GLI ORIGINALI RAPIER TAPES FOR SULZER RÜTI LOOMS INTERCHANGEABLE WITH THE ORIGINALS

MODELLO G6200
 MODEL G6200

MATERIE PRIME
 RAW MATERIALS

CARBONIO
 CARBON FIBER,

ALT. TELAIO LOOM WIDTH	LUNG. NASTRO TAPE LENGTH	Fibercompositi CODICE / CODE
	1884 mm.	24011884C
	2134 mm.	24012134C
	2434 mm.	24012434C
	2684 mm.	24012684C

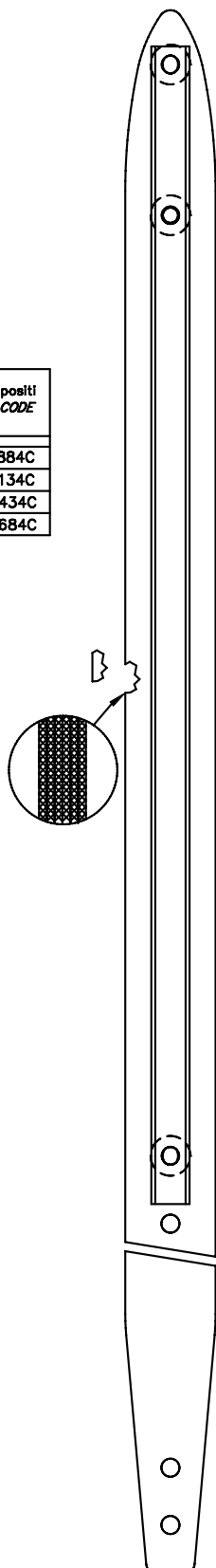

MODELLO G6500
 MODEL G6500

MATERIE PRIME
 RAW MATERIALS

CARBONIO
 CARBON FIBER,

ALT. TELAIO LOOM WIDTH	LUNG. NASTRO TAPE LENGTH	Fibercompositi CODICE / CODE
150-170	2510 mm	24052510
190-220	2763 mm	24052763
240-260	2961 mm	24052961
280	3060 mm	24053060
320-340	3357 mm	24053357
360	3467 mm	24053467

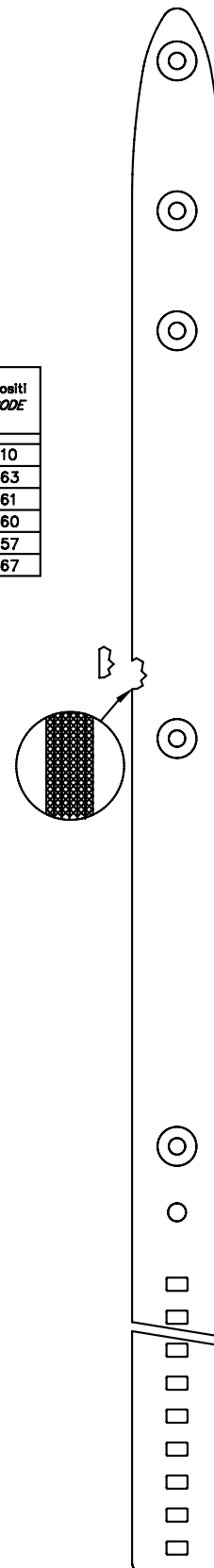

PROFILO COMPLETO PER TELAI DORNIER INTERCAMBIABILE CON L'ORIGINALE
COMPLETE PROFILE FOR DORNIER LOOMS INTERCHANGEABLE WITH THE ORIGINAL

MODELLO H ATTACCO PINZA INTERNO
MODEL H INNER GRIPPER CONNECTION

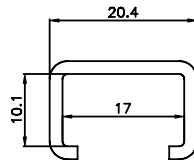

ALT. TELAIO LOOM WIDTH	LUNG.LANCIA TUBE LENGTH	Fibercompositi CODICE /CODE
H. 1800 mm.	1147 mm.	52011147
H. 1900 mm.	1197 mm.	52011197
H. 2000 mm.	1247 mm.	52011247
H. 2100 mm.	1297 mm.	52011297
H. 2200 mm.	1347 mm.	52011347
H. 2300 mm.	1397 mm.	52011397
H. 2400 mm.	1447 mm.	52011447
H. 2500 mm.	1497 mm.	52011497
H. 2600 mm.	1547 mm.	52011547
H. 2800 mm.	1647 mm.	52011647
H. 3000 mm.	1747 mm.	52011747
H. 3100 mm.	1797 mm.	52011797
H. 3200 mm.	1847 mm.	52011847
H. 3400 mm.	1947 mm.	52011947
H. 3600 mm.	2047 mm.	52012047
H. 3800 mm.	2147 mm.	52012147
H. 4000 mm.	2247 mm.	52012247

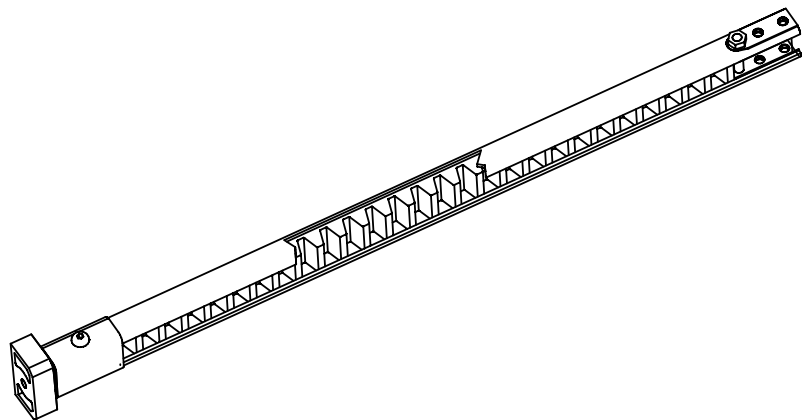

MODELLO H ATTACCO PINZA ESTERNO
MODEL H OUTER GRIPPER CONNECTION

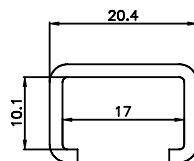

ALT. TELAIO LOOM WIDTH	LUNG.LANCIA TUBE LENGTH	Fibercompositi CODICE /CODE
H. 1800 mm.	1147 mm.	52021147
H. 1900 mm.	1197 mm.	52021197
H. 2000 mm.	1247 mm.	52021247
H. 2100 mm.	1297 mm.	52021297
H. 2200 mm.	1347 mm.	52021347
H. 2300 mm.	1397 mm.	52021397
H. 2400 mm.	1447 mm.	52021447
H. 2500 mm.	1497 mm.	52021497
H. 2600 mm.	1547 mm.	52021547
H. 2800 mm.	1647 mm.	52021647
H. 3000 mm.	1747 mm.	52021747
H. 3100 mm.	1797 mm.	52021797
H. 3200 mm.	1847 mm.	52021847
H. 3400 mm.	1947 mm.	52021947
H. 3600 mm.	2047 mm.	52022047
H. 3800 mm.	2147 mm.	52022147
H. 4000 mm.	2247 mm.	52022247

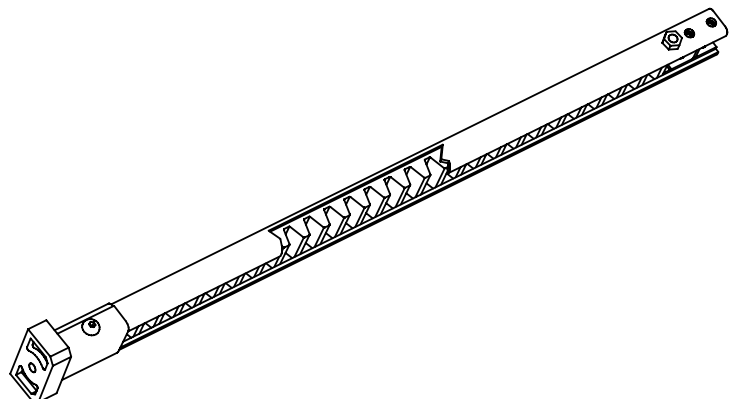

PROFILO COMPLETO PER TELAI DORNIER INTERCAMBIABILE CON L'ORIGINALE COMPLETE PROFILE FOR DORNIER LOOMS INTERCHANGEABLE WITH THE ORIGINAL

MODELLO G MODEL G

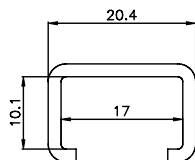

ALT. TELAIO LOOM WIDTH	LUNG.LANCIA TUBE LENGTH	Fibercompositi CODICE/CODE
H. 1500 mm.	1070 mm.	52031070
H. 1600 mm.	1120 mm.	52031120
H. 1700 mm.	1170 mm.	52031170
H. 1800 mm.	1220 mm.	52031220
H. 1900 mm.	1270 mm.	52031270
H. 2000 mm.	1320 mm.	52031320
H. 2100 mm.	1370 mm.	52031370
H. 2200 mm.	1420 mm.	52031420
H. 2300 mm.	1470 mm.	52031470
H. 2400 mm.	1520 mm.	52031520
H. 2500 mm.	1570 mm.	52031570
H. 2600 mm.	1620 mm.	52031620
H. 2700 mm.	1670 mm.	52031670
H. 2800 mm.	1720 mm.	52031720
H. 2900 mm.	1770 mm.	52031770
H. 3000 mm.	1820 mm.	52031820
H. 3200 mm.	1920 mm.	52031920
H. 3300 mm.	1970 mm.	52031970
H. 3400 mm.	2020 mm.	52032020
H. 3500 mm.	2070 mm.	52032070
H. 3600 mm.	2120 mm.	52032120
H. 3800 mm.	2220 mm.	52032220
H. 4000 mm.	2320 mm.	52032320

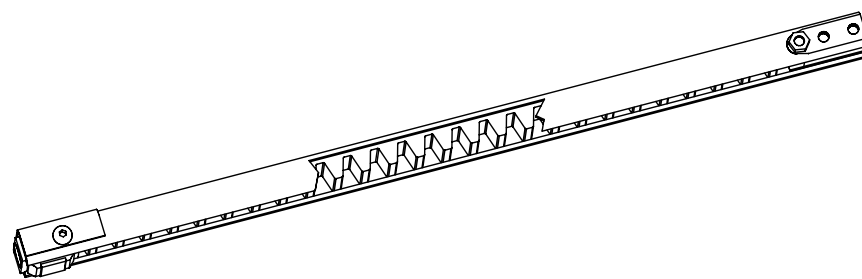

MODELLO PTV/PTS MODEL PTV/PTS

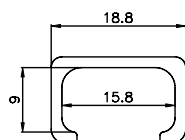

ALT. TELAIO LOOM WIDTH	LUNG.LANCIA TUBE LENGTH	Fibercompositi CODICE/CODE
H. 1800 mm.	1147 mm.	52081147
H. 1900 mm.	1197 mm.	52081197
H. 2000 mm.	1247 mm.	52081247
H. 2100 mm.	1297 mm.	52081297
H. 2200 mm.	1347 mm.	52081347
H. 2300 mm.	1397 mm.	52081397
H. 2400 mm.	1447 mm.	52081447
H. 2500 mm.	1497 mm.	52081497
H. 2600 mm.	1547 mm.	52081547
H. 2800 mm.	1647 mm.	52081647
H. 3000 mm.	1747 mm.	52081747
H. 3100 mm.	1797 mm.	52081797
H. 3200 mm.	1847 mm.	52081847
H. 3400 mm.	1947 mm.	52081947
H. 3600 mm.	2047 mm.	52082047
H. 3800 mm.	2147 mm.	52082147
H. 4000 mm.	2247 mm.	52082247

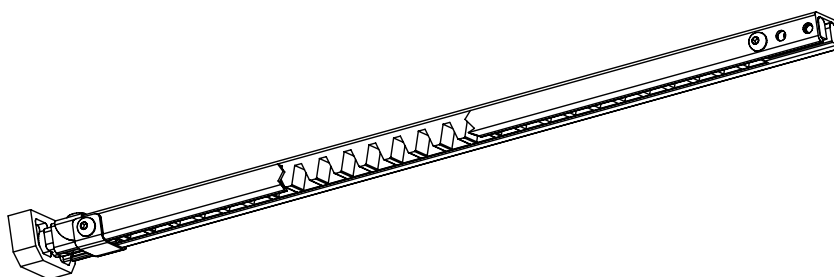

PROFILO PER TELAI DORNIER INTERCAMBIABILE CON L'ORIGINALE
PROFILE FOR DORNIER LOOMS INTERCHANGEABLE WITH THE ORIGINAL

MODELLO HTVS
MODEL HTVS

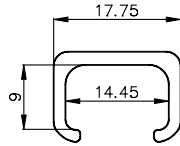

ALT. TELAIO LOOM WIDTH	LUNG.LANCIA TUBE LENGTH	Fibercompositi CODICE / CODE
H. 1600 mm.	1050 mm.	52131050
H. 1700 mm.	1100mm.	52131100
H. 1800 mm.	1150 mm.	52131150
H. 1900 mm.	1200 mm.	52131200
H. 2000 mm.	1250 mm.	52131250
H. 2100 mm.	1300 mm.	52131300
H. 2200 mm.	1350 mm.	52131350
H. 2300 mm.	1400 mm.	52131400
H. 2400 mm.	1450 mm.	52131450
H. 2500 mm.	1500 mm.	52131500
H. 2600 mm.	1550 mm.	52131550
H. 2700 mm.	1600 mm.	52131600
H. 2800 mm.	1650 mm.	52131650
H. 2900 mm.	1700 mm.	52131700
H. 3000 mm.	1750 mm.	52131750
H. 3100 mm.	1800 mm.	52131800
H. 3200 mm.	1850 mm.	52131850
H. 3300 mm.	1900 mm.	52131900
H. 3400 mm.	1950 mm.	52131950
H. 3500 mm.	2000 mm.	52132000
H. 3600 mm.	2050 mm.	52132050
H. 3800 mm.	2150 mm.	52132150

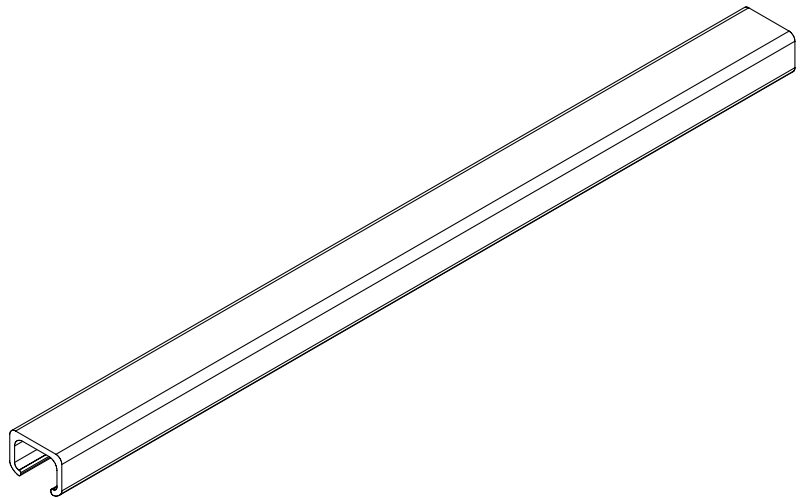

PARTI DI RICAMBIO PER TELAI PANTER INTERCAMBIABILI CON GLI ORIGINALI
SPARE PARTS FOR PANTER LOOMS INTERCHANGEABLE WITH THE ORIGINALS

RUOTA DENTATA PANTER Z102
PANTER DRIVE WHEEL Z102
COD.6304

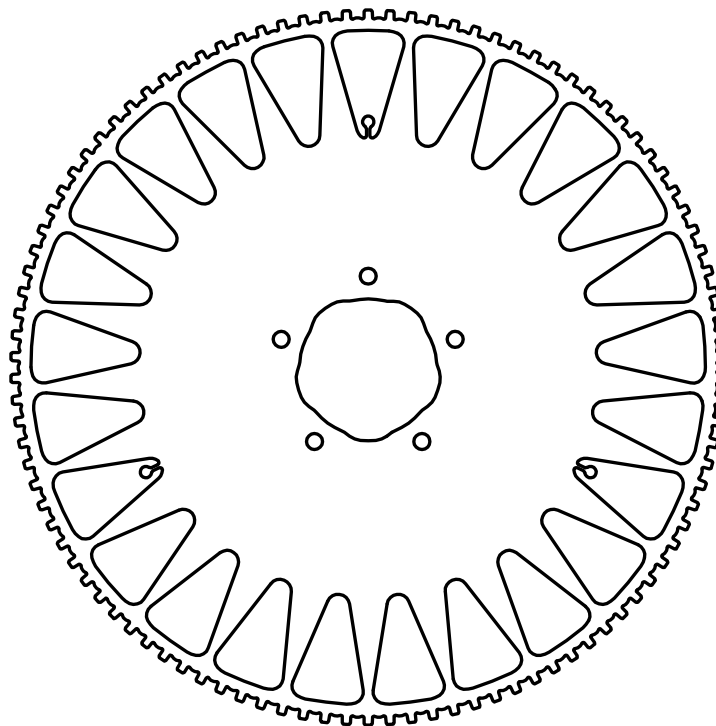

RUOTA DENTATA PANTER Z131
PANTER DRIVE WHEEL Z131
COD.6305

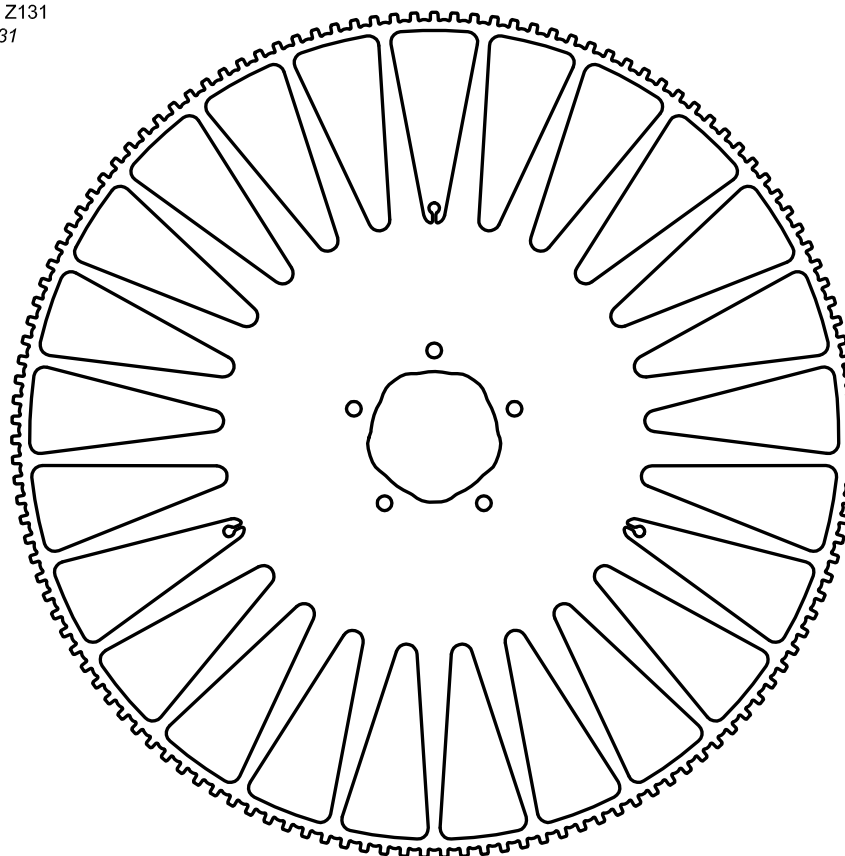

PARTI DI RICAMBIO PER TELAI PANTER INTERCAMBIABILI CON GLI ORIGINALI
SPARE PARTS FOR PANTER LOOMS INTERCHANGEABLE WITH THE ORIGINALS



COD.6306002

APRIPINZA PANTER IN KEVLAR
PANTER OPENER IN KEVLAR

NASTRI PER TELAI PANTER INTERCAMBIABILI CON GLI ORIGINALI RAPIER TAPES FOR LOOMS PANTER INTERCHANGEABLE WITH THE ORIGINALS

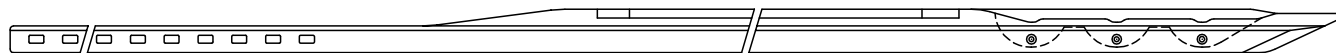

NASTRO PANTER PINZA NEGATIVA SINISTRO
PANTER RAPIER TAPE NEGATIVE GRIPPER LEFT

ALT. TELAIO LOOM WIDTH	LUNG. NASTRO TAPE LENGTH	Fibercompositi CODICE/CODE	ALT. TELAIO LOOM WIDTH	LUNG. NASTRO TAPE LENGTH	Fibercompositi CODICE/CODE
1600	2142	63012142S	2800	2742	63012742S
1900	2287	63012287S	3000	2837	63012837S
2100	2392	63012392S	3200	2932	63012932S
2300	2487	63012487S	3400	3027	63013027S
2400	2562	63012562S	3600	3122	63013122S
2600	2647	63012647S	3800	3217	63013217S

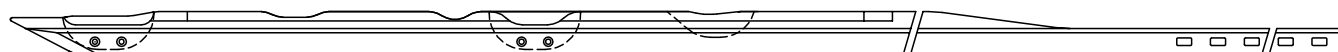

NASTRO PANTER PINZA NEGATIVA DESTRO
PANTER RAPIER TAPE NEGATIVE GRIPPER RIGHT

ALT. TELAIO LOOM WIDTH	LUNG. NASTRO TAPE LENGTH	Fibercompositi CODICE/CODE	ALT. TELAIO LOOM WIDTH	LUNG. NASTRO TAPE LENGTH	Fibercompositi CODICE/CODE
1600	2142	63012142D	2800	2742	63012742D
1900	2287	63012287D	3000	2837	63012837D
2100	2392	63012392D	3200	2932	63012932D
2300	2487	63012487D	3400	3027	63013027D
2400	2562	63012562D	3600	3122	63013122D
2600	2647	63012647D	3800	3217	63013217D



NASTRO PANTER PINZA POSITIVA SINISTRO
PANTER RAPIER TAPE POSITIVE GRIPPER LEFT

ALT. TELAIO LOOM WIDTH	LUNG. NASTRO TAPE LENGTH	Fibercompositi CODICE/CODE
1900	2292	63022292S
2300	2500	63022500S
3400	3034	63023034S



NASTRO PANTER PINZA POSITIVA DESTRO
PANTER RAPIER TAPE POSITIVE GRIPPER RIGHT

ALT. TELAIO LOOM WIDTH	LUNG. NASTRO TAPE LENGTH	Fibercompositi CODICE/CODE
1900	2292	63022292D
2300	2500	63022500D
3400	3034	63023034D

NASTRI PER MACCHINE ZELLWEGER / STÄUBLI INTERCAMBIABILI CON GLI ORIGINALI
TAPES FOR ZELLWEGER / STÄUBLI MACHINES INTERCHANGEABLE WITH THE ORIGINALS

LUNG. NASTRO TAPE LENGTH	CODICE / CODE
1250	81011250

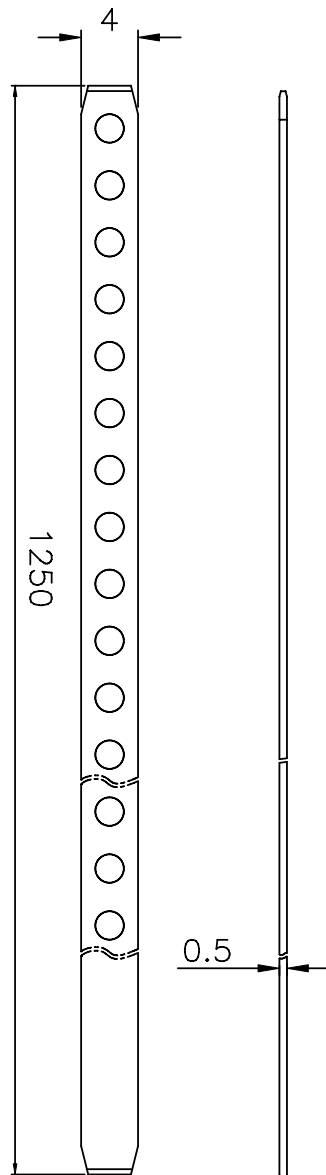

LUNG. NASTRO TAPE LENGTH	CODICE / CODE
1398	81011400

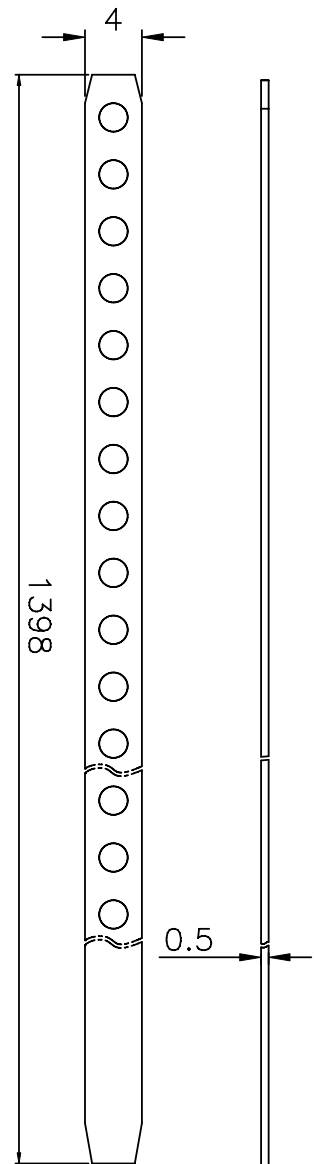

NASTRI PER TELAI VAN DE WIELE INTERCambiabili CON GLI ORIGINALI
RAPIER TAPES FOR LOOMS VAN DE WIELE INTERCHANGEABLE WITH THE ORIGINALS

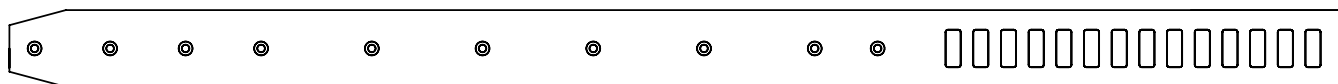

NASTRO VAN DE WIELE
 VAN DE WIELE RAPIER TAPE

CODE	18013170	18011915	18012410	18012255	18012970	18013905	18013360
LENGHT	3170	1915	2410	2255	2970	3095	3360

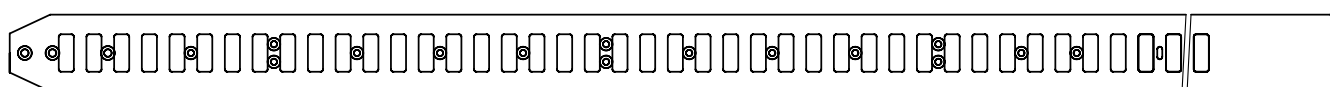

NASTRO VAN DE WIELE
 VAN DE WIELE RAPIER TAPE

CODE	18073215	18073551					
LENGHT	3215	3551					

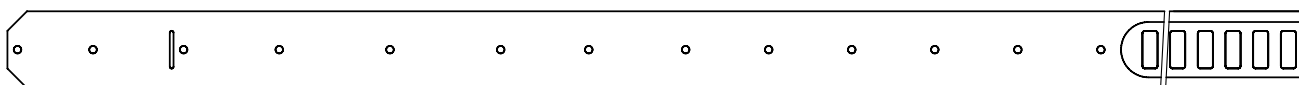

NASTRO VAN DE WIELE
 VAN DE WIELE RAPIER TAPE

CODE	18062417	18062472	18062670	18063418
	18062417C1	18062472C1	18062670C1	18063418C1
LENGHT	2417	2472	2670	3418

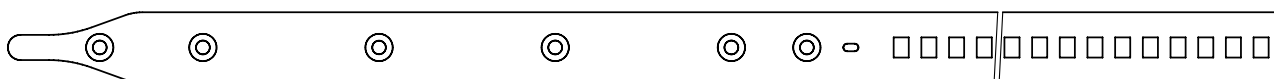

NASTRO VAN DE WIELE IN FIBRA DI CARBONIO
 VAN DE WIELE RAPIER TAPE IN CARBON FIBRE

CODE	18043410
LENGHT	3410

PARTI DI RICAMBIO PER TELAI VAN DE WIELE INTERCambiabili CON GLI ORIGINALI
SPARE PARTS FOR VAN DE WIELE LOOMS INTERCHANGEABLE WITH THE ORIGINALS

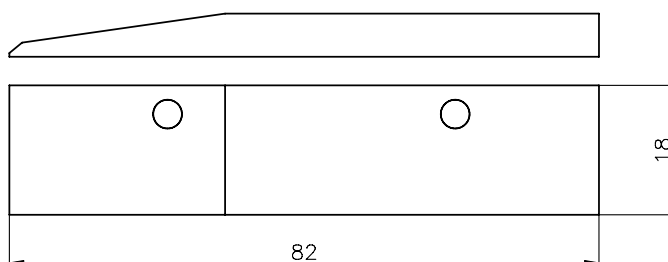

CODE	1802

PATTINO APRIPINZA
 GRIPPER OPENING SLIDING BLOCK

PARTI DI RICAMBIO PER TELAI JUERGENS INTERCambiabili CON GLI ORIGINALI
SPARE PARTS FOR JUERGENS LOOMS INTERCHANGEABLE WITH THE ORIGINALS

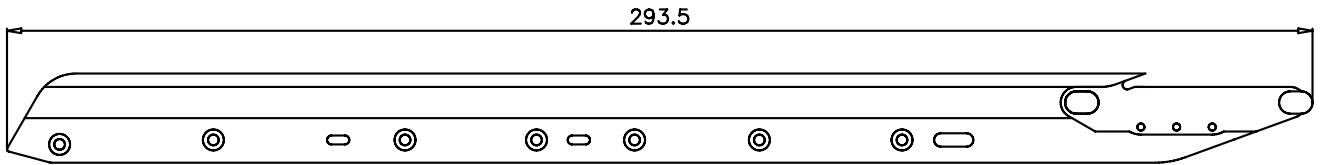

COD.5306180D
 PUNTA CARBONIO PER NASTRO MFG DX (MOD. JUERGENS)
 CARBON TOP FOR MFG TAPE RIGHT (MOD. JUERGENS)

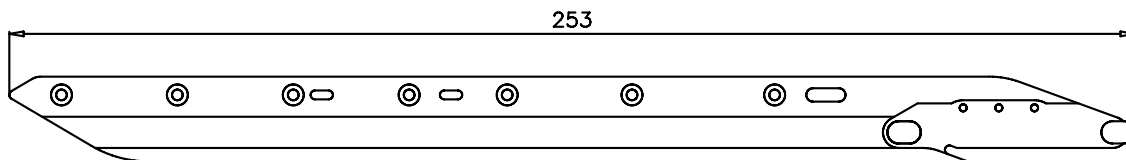

COD.5306181S
 PUNTA CARBONIO PER NASTRO MFG SX (MOD. JUERGENS)
 CARBON TOP FOR MFG TAPE LEFT (MOD. JUERGENS)

PARTI DI RICAMBIO PER TELAI JAEGER INTERCambiabili CON GLI ORIGINALI
SPARE PARTS FOR JAEGER LOOMS INTERCHANGEABLE WITH THE ORIGINALS

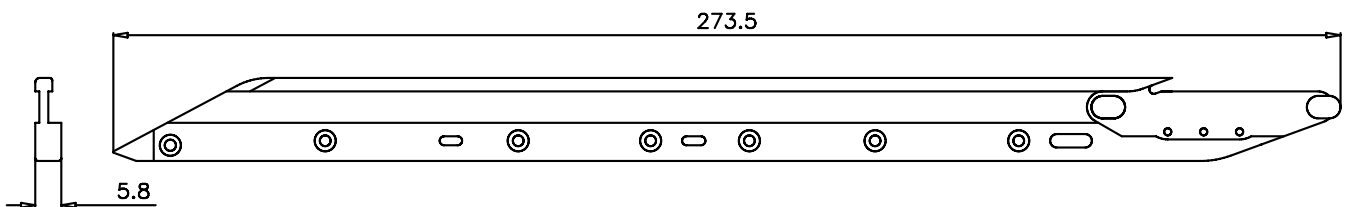

COD.7501R
 PUNTA JAEGER DX SPESSORE 3.8/5.8 mm IN CARBONIO
 JAEGER TOP RIGHT THICKNESS 3.8/5.8 mm IN CARBON

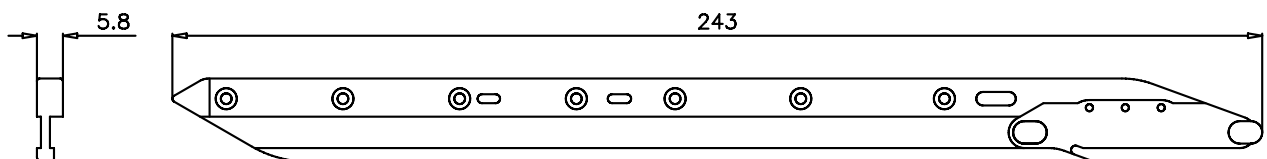

COD.7501L
 PUNTA JAEGER SX SPESSORE 3.8/5.8 mm IN CARBONIO
 JAEGER TOP LEFT THICKNESS 3.8/5.8 mm IN CARBON

NASTRI PER TELAI INTERCAMBIABILI CON GLI ORIGINALI
RAPIER TAPES FOR LOOMS INTERCHANGEABLE WITH THE ORIGINALS

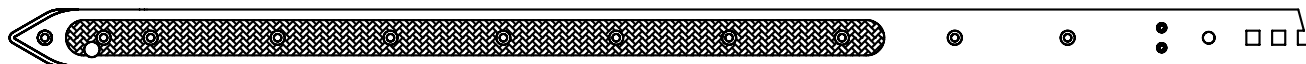

COD. 1401_ _ _ _L NASTRO ISHIKAWA 1001 PER SUPPORTO IN CARBONIO LARGHEZZA 24 mm. SINISTRO
 ISHIKAWA RAPIER TAPE 1001 FOR CARBON SUPPORT WIDTH 24 mm. LEFT

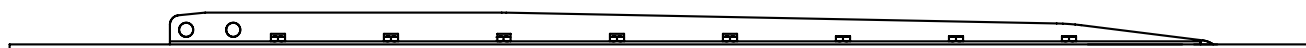

COD. 1401_ _ _ _LC NASTRO ISHIKAWA 1001 CON SUPPORTO IN CARBONIO LARGHEZZA 24 mm. SINISTRO
 ISHIKAWA RAPIER TAPE 1001 WITH CARBON SUPPORT WIDTH 24 mm. LEFT

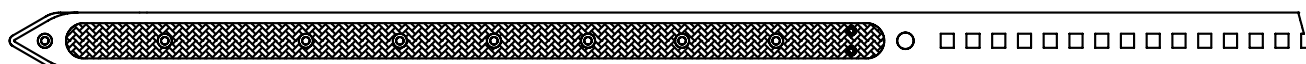

COD. 1401_ _ _ _R NASTRO ISHIKAWA 1001 PER SUPPORTO IN CARBONIO LARGHEZZA 24 mm. DESTRO
 ISHIKAWA RAPIER TAPE 1001 FOR CARBON SUPPORT WIDTH 24 mm. RIGHT

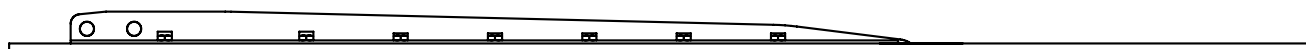

COD. 1401_ _ _ _RC NASTRO ISHIKAWA 1001 CON SUPPORTO IN CARBONIO LARGHEZZA 24 mm. DESTRO
 ISHIKAWA RAPIER TAPE 1001 WITH CARBON SUPPORT WIDTH 24 mm. RIGHT

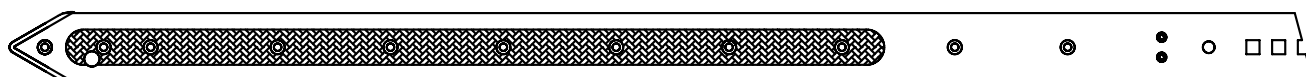

COD. 1402_ _ _ _L NASTRO ISHIKAWA 1001 PER SUPPORTO IN CARBONIO LARGHEZZA 30 mm. SINISTRO
 ISHIKAWA RAPIER TAPE 1001 FOR CARBON SUPPORT WIDTH 30 mm. LEFT



COD. 1402_ _ _ _R NASTRO ISHIKAWA 1001 PER SUPPORTO IN CARBONIO LARGHEZZA 30 mm. DESTRO
 ISHIKAWA RAPIER TAPE 1001 FOR CARBON SUPPORT WIDTH 30 mm. RIGHT

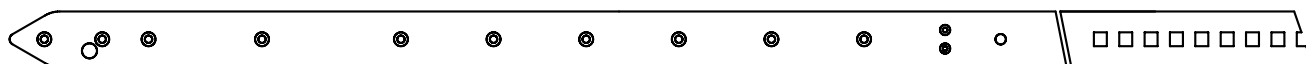

COD. 1404_ _ _ _L NASTRO ISHIKAWA 1001 PER SUPPORTO IN NYLON LARGHEZZA 24 mm. SINISTRO
 ISHIKAWA RAPIER TAPE 1001 FOR NYLON SUPPORT WIDTH 24 mm. LEFT

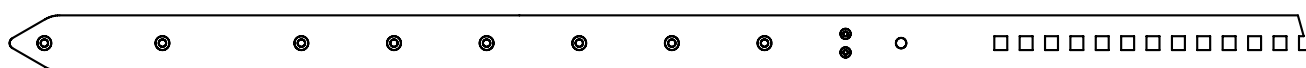

COD. 1404_ _ _ _R NASTRO ISHIKAWA 1001 PER SUPPORTO IN NYLON LARGHEZZA 24 mm. DESTRO
 ISHIKAWA RAPIER TAPE 1001 FOR NYLON SUPPORT WIDTH 24 mm. RIGHT

NASTRI PER TELAI INTERCambiabili CON GLI ORIGINALI
RAPIER TAPES FOR LOOMS INTERCHANGEABLE WITH THE ORIGINALS

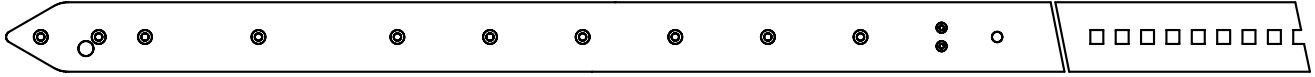

COD. 1405_ _ _ _L NASTRO ISHIKAWA 1001 PER SUPPORTO IN NYLON LARGHEZZA 30 mm. SINISTRO
 ISHIKAWA RAPIER TAPE 1001 FOR NYLON SUPPORT WIDTH 30 mm. LEFT



COD. 1405_ _ _ _R NASTRO ISHIKAWA 1001 PER SUPPORTO IN NYLON LARGHEZZA 30 mm. DESTRO
 ISHIKAWA RAPIER TAPE 1001 FOR NYLON SUPPORT WIDTH 30 mm. RIGHT



LUNG. NASTRO TAPE LENGTH	Fibercompositi CODICE/ CODE
2740 mm	14032740
2750 mm	14032750

NASTRO ISHIKAWA 2001E IN CARBONIO
 ISHIKAWA RAPIER TAPE 2001E IN CARBON

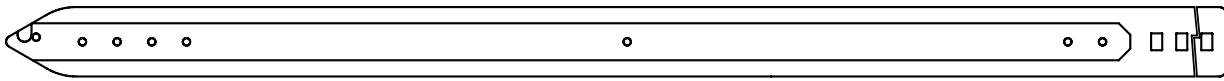

LUNG. NASTRO TAPE LENGTH	Fibercompositi CODICE/ CODE
2740 mm	14062740
2795 mm	14062795

NASTRO ISHIKAWA 2001S IN CARBONIO
 ISHIKAWA RAPIER TAPE 2001S IN CARBON

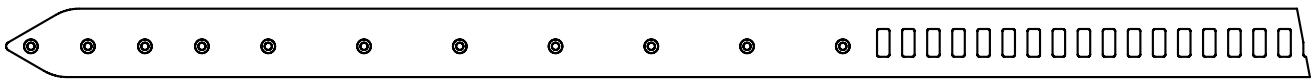

COD. 1503_ _ _ _ NASTRO TSUDAKOMA R300 TRANCIATURA AC2S
 TSUDAKOMA RAPIER TAPE R300 AC2S PUNCHING



COD. 1501_ _ _ _ NASTRO TSUDAKOMA FR-001
 TSUDAKOMA RAPIER TAPE FR-001

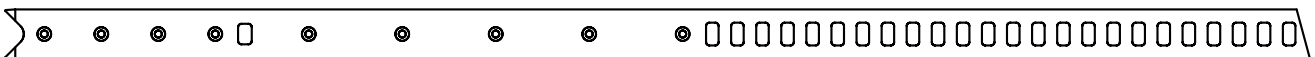

COD. 1502_ _ _ _ NASTRO TSUDAKOMA R550
 TSUDAKOMA RAPIER TAPE R550

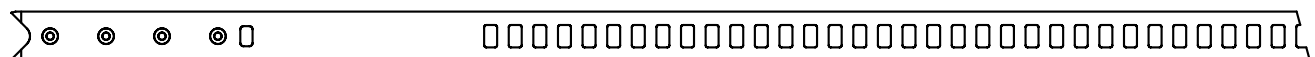

COD. 1505_ _ _ _ NASTRO TSUDAKOMA R550
 TSUDAKOMA RAPIER TAPE R550

NASTRI PER TELAI INTERCAMBIABILI CON GLI ORIGINALI
RAPIER TAPES FOR LOOMS INTERCHANGEABLE WITH THE ORIGINALS



COD. 1504_ _ _ _ NASTRO TSUDAKOMA R300
 TSUDAKOMA RAPIER TAPE R300

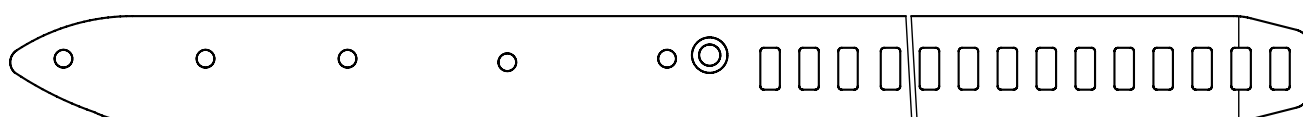

COD. 1601_ _ _ _ NASTRO IMAMURA TG107
 IMAMURA RAPIER TAPE TG107

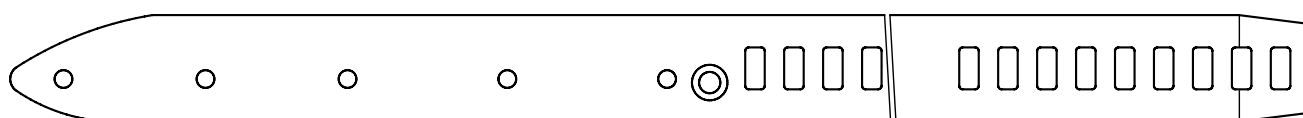

COD. 1602_ _ _ _ NASTRO IMAMURA SR107
 IMAMURA RAPIER TAPE SR107

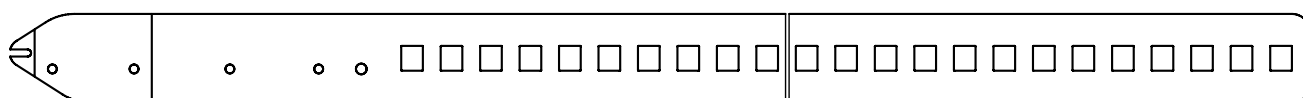

COD. 1701_ _ _ _S NASTRO P. MAIA TSL 500 SINISTRO
 P. MAIA RAPIER TAPE TSL 500 LEFT

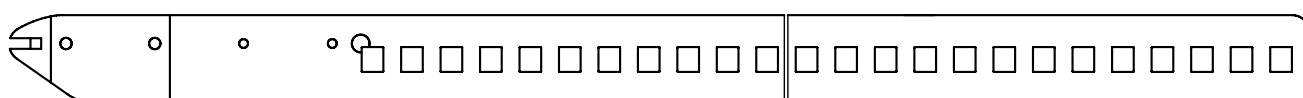

COD. 1701_ _ _ _D NASTRO P. MAIA TSL 500 DESTRO
 P. MAIA RAPIER TAPE TSL 500 RIGHT

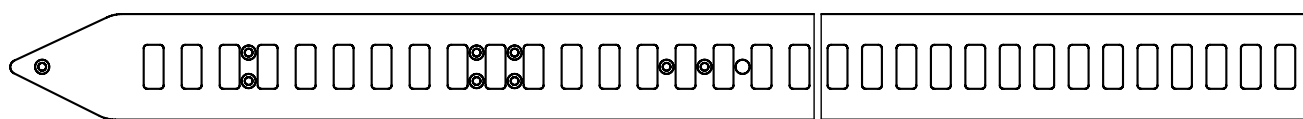

COD. 1702_ _ _ _ NASTRO P. MAIA ANCE
 P. MAIA RAPIER TAPE ANCE

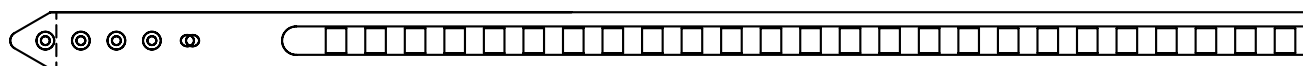

COD. 1705_ _ _ _ NASTRO P. MAIA TSL600 LARGHEZZA 16 mm
 P. MAIA RAPIER TAPE TSL600 WIDTH 16 mm

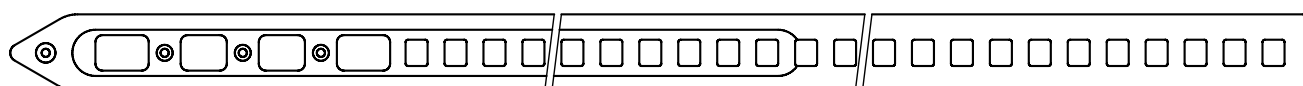

COD. 1901_ _ _ _ NASTRO SOMET ST880 TRANCIATURA MASTER
 SOMET RAPIER TAPE ST880 WITH MASTER SHEARING

NASTRI PER TELAI INTERCAMBIABILI CON GLI ORIGINALI
RAPIER TAPES FOR LOOMS INTERCHANGEABLE WITH THE ORIGINALS

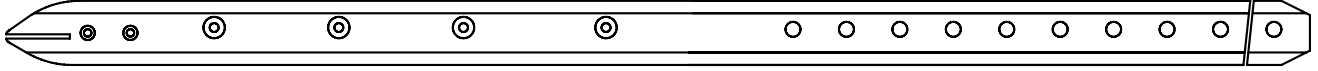

COD. 22011092S

NASTRO JAKOB MULLER MBJ3 [MBJ3.1] LARGHEZZA 18mm SINISTRO
 JAKOB MULLER RAPIER TAPE MBJ3 [MBJ3.1] WIDTH 18mm LEFT

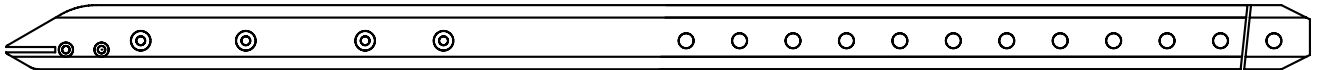

COD. 22011077D

NASTRO JAKOB MULLER MBJ3 LARGHEZZA 18mm DESTRO
 JAKOB MULLER RAPIER TAPE MBJ3 WIDTH 18mm RIGHT

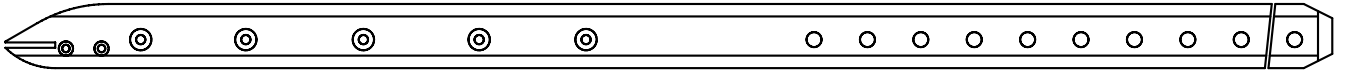

COD. 22051077D

NASTRO JAKOB MULLER MBJ3.1 LARGHEZZA 18mm DESTRO
 JAKOB MULLER RAPIER TAPE MBJ3.1 WIDTH 18mm RIGHT



COD. 2202946D

NASTRO JAKOB MULLER MBJ2 LARGHEZZA 16mm DESTRO
 JAKOB MULLER RAPIER TAPE MBJ2 WIDTH 16mm RIGHT



COD. 2202952S

NASTRO JAKOB MULLER MBJ2 LARGHEZZA 16mm SINISTRO
 JAKOB MULLER RAPIER TAPE MBJ2 WIDTH 16mm LEFT

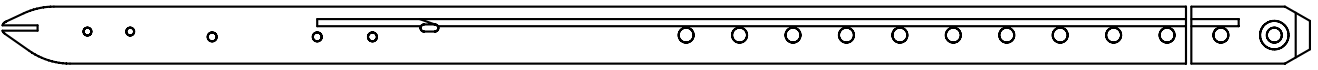

COD. 2203952S

NASTRO JAKOB MULLER MBJ2 LARGHEZZA 16mm SINISTRO
 JAKOB MULLER RAPIER TAPE MBJ2 WIDTH 16mm LEFT

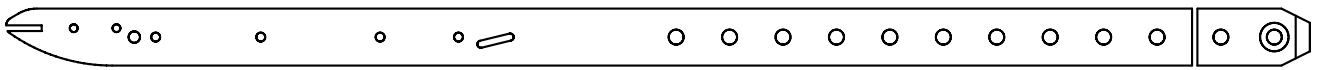

COD. 2204946D

NASTRO JAKOB MULLER MBJ1 LARGHEZZA 16mm DESTRO SENZA CORDINO
 JAKOB MULLER RAPIER TAPE MBJ1 WIDTH 16mm RIGHT WITHOUT GREEN CORD

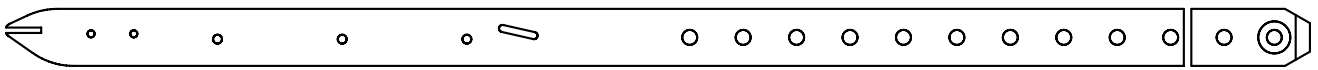

COD. 2204946S

NASTRO JAKOB MULLER MBJ1 LARGHEZZA 16mm SINISTRO SENZA CORDINO
 JAKOB MULLER RAPIER TAPE MBJ1 WIDTH 16mm LEFT WITHOUT GREEN CORD

NASTRI PER TELAI INTERCAMBIABILI CON GLI ORIGINALI
RAPIER TAPES FOR LOOMS INTERCHANGEABLE WITH THE ORIGINALS

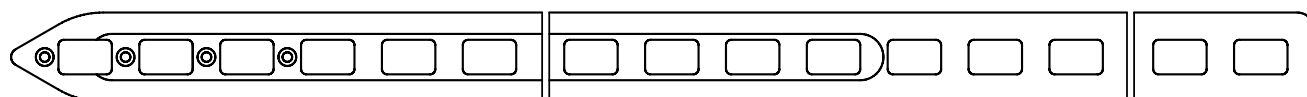

NASTRO IWAMA
 IWAMA RAPIER TAPE
 COD. 2101_ _ _ _

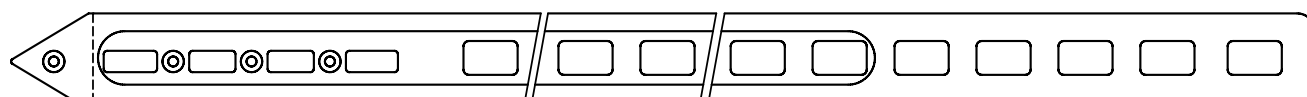

NASTRO IWAMA RT500 PUNTA MASTER
 IWAMA RAPIER TAPE MODEL RT500 MASTER TOP
 COD. 2102_ _ _ _

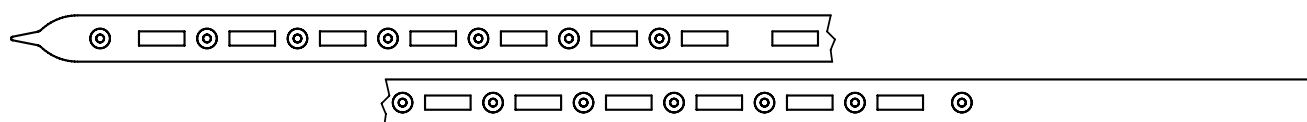

NASTRO SAURER R350
 SAURER RAPIER TAPE R350
 COD. 2001_ _ _ _

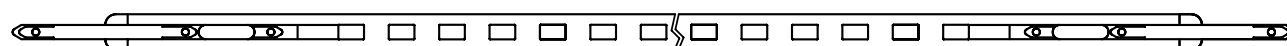

NASTRO SAURER S400
 SAURER RAPIER TAPE S400
 COD. 2002_ _ _ _

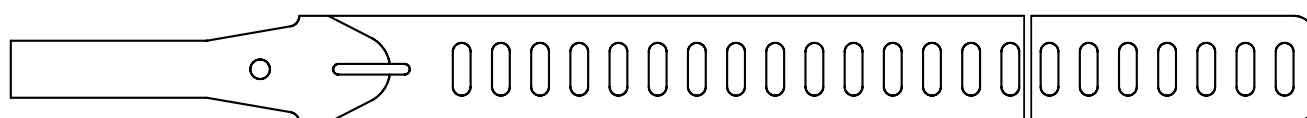

NASTRO HIRAIWA HUS
 HIRAIWA RAPIER TAPE HUS
 COD. 2301_ _ _ _

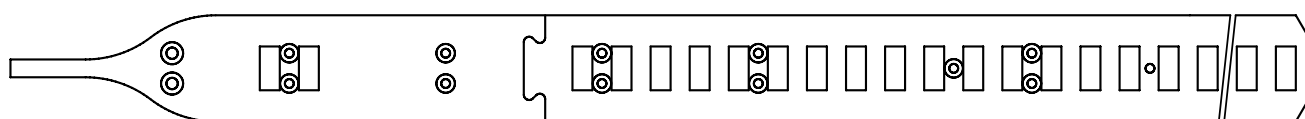

PUNTA INTERCAMBIABILE
 INTERCHANGEABLE TOP
 COD. 5107

NASTRO MERTENS PUNTA INTERCAMBIABILE
 MERTENS RAPIER TAPE INTERCHANGEABLE
 COD. 5106_ _ _ _

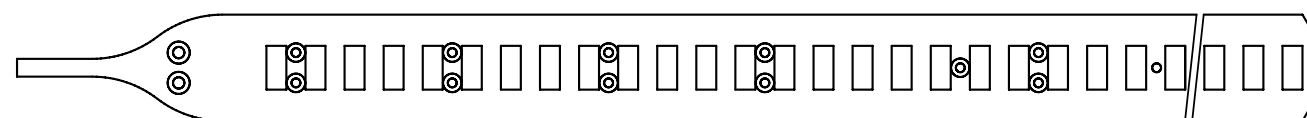

NASTRO MERTENS
 MERTENS RAPIER TAPE
 COD. 5101_ _ _ _



NASTRO IWAMA RT300 IN FIBRA DI VETRO
 IWAMA RT300 RAPIER TAPE IN GLASS FIBRE
 COD.2109_ _ _ _



Fibercompositi srl
Via Faccononi, 6 - 24020 Cerete Basso (BG) - Italy
Tel +39 0346 63248 - Fax +39 0346 63390
info@fibercompositi.it - www.fibercompositi.it