

Material Handling Systems



Crates and Trolleys

Rimtex offers wide range of material handling and internal transportation solutions.

It has taken special care of specific requirement like Steaming, Doffing etc. for Sliver, Bobbins, Cops, Yarns, Fabric etc.

It offers Stackable models with perforated and non-perforated, ribbed and without ribbed, aluminum body. Facilitated with Spring loaded bottom

and minimum maintenance Castors.

Rimtex Trolleys are also available as per customers specification to suit space and volume availability.

They truly help to preserve quality and bring work pleasure, out of rigid monotonous work. It helps to save space and increases efficiency.

They are more economical in the long run.



- **Model R-101**

- **Utility**

Auto doffing and transportation

- **Technical specification**

Aluminum trolley, with pantograph, non-perforated, with rib, duly anodized, with castors



Dimensions

External Dimensions	Internal Dimensions	Castor
820 x 530 x 910 h	800 x 510 x 722 h	Ø 125
1030 x 630 x 910 h	1010 x 610 x 722 h	Ø 125
1130 x 480 x 910 h	1110 x 460 x 722 h	Ø 125
1390 x 730 x 910 h	1370 x 710 x 722 h	Ø 125
1280 x 480 x 1055 h	1260 x 460 x 900 h	Ø 100
1130 x 730 x 910 h	1110 x 710 x 722 h	Ø 125
1390 x 730 x 1055 h	1370 x 710 x 900 h	Ø 100

• Other Dimensions on request



- **Model R-102**
- **Utility**
Auto doffing and Transportation.
- **Technical Specification:**
Aluminum trolley, with pantograph, perforated, with rib, duly anodized, with castors

Dimensions

External Dimensions	Internal Dimensions	Castor
820 x 530 x 910 h	800 x 510 x 722 h	Ø 125
1030 x 630 x 910 h	1010 x 610 x 722 h	Ø 125
1130 x 480 x 910 h	1110 x 460 x 722 h	Ø 125
1390 x 730 x 910 h	1370 x 710 x 722 h	Ø 125
1280 x 480 x 1055 h	1260 x 460 x 900 h	Ø 100
1130 x 730 x 910 h	1110 x 710 x 722 h	Ø 125
1390 x 730 x 1055 h	1370 x 710 x 900 h	Ø 100

- Other Dimensions on request

- **Model R-103**

- **Utility**

- Steaming, Transportation,
Laundry Washing.

- **Technical Specification**

- Aluminum trolley, with hinged type door, without-pantograph, perforated, with-rib, duly-anodized, with stainless steel castor.s



Dimensions

External Dimensions	Internal Dimensions	Castor
1330 x 730 x 1110 h	1310 x 710 x 902 h	Ø150
1130 x 680 x 1110 h	1110 x 660 x 902 h	Ø150
950 x 770 x 980 h	930 x 750 x 792 h	Ø125

- Other Dimensions on request



- **Model R-104**
- **Utility**
Transportation, Doffing,
Laundry Washing.
- **Technical Specification**
Aluminum trolley, cut out at one
length side, without-pantograph,
non-perforated, with-rib,
duly-anodized, with castors

Dimensions

External Dimensions	Internal Dimensions	Castor
1500 x 930 x 865 h	1480 x 910 x 657 h	Ø150
1200 x 1000 x 910 h	1180 x 980 x 722 h	Ø125

- Other Dimensions on request

- **Model R-105**

- **Utility**

Manual doffing of cops at ring spinning machine and ring twister; steaming of yarns in the steamer; feeding of cross bobbin winder.

- **Technical Specification**

Aluminum basket, perforated, with rib, stackable, duly anodized.



Dimensions

External dimensions	Internal Dimensions
600 x 400 x 320 h	578 x 378 x 297 h
610 x 410 x 375 h	588 x 388 x 352 h
400 x 300 x 320 h	378 x 278 x 297 h
613 x 413 x 490 h	591 x 391 x 467 h
768 x 488 x 460 h	746 x 466 x 437 h
768 x 488 x 590 h	746 x 466 x 597 h

- Other Dimensions on request



- **Model R-106**
- **Utility**
Manual doffing of cops at ring spinning machine and ring twister; steaming of yarns in the steamer; feeding of cross bobbin winder.
- **Technical Specification**
Aluminum basket, non-perforated, with rib, stackable, duly anodized.

Dimensions

External dimensions	Internal Dimensions
600 x 400 x 320 h	578 x 378 x 297 h
610 x 410 x 375 h	588 x 388 x 352 h
400 x 300 x 320 h	378 x 278 x 297 h
613 x 413 x 490 h	591 x 391 x 467 h
768 x 488 x 460 h	746 x 466 x 437 h
768 x 488 x 590 h	746 x 466 x 597 h

- Other Dimensions on request

- **Model R-107**

- **Utility**

Steaming, Auto doffing,
Transportation, Laundry Washing.

- **Technical Specification**

Aluminum steaming trolley,
without pantograph, perforated,
with rib, duly anodized,
with stainless steel castors



Dimensions

External Dimensions	Internal Dimensions	Castor
1030 x 530 x 795 h	1010 x 510 x 640 h	Ø100
1030 x 630 x 795 h	1010 x 610 x 640 h	Ø100
950 x 710 x 895 h	930 x 690 x 707 h	Ø125
1230 x 830 x 795 h	1210 x 810 x 607 h	Ø125
1330 x 730 x 795 h	1310 x 710 x 607 h	Ø125
1330 x 730 x 895 h	1310 x 710 x 707 h	Ø125
1290 x 800 x 895 h	1270 x 780 x 707 h	Ø125

- Other Dimensions on request



- **Model R-108**
- **Utility**
Auto doffing, Transportation
Laundry Washing.
- **Technical specification**
Aluminum trolley, without-pantograph,
non-perforated, with rib,
duly-anodized, with castors

Dimensions

External Dimensions	Internal Dimensions	Castor
1030 x 530 x 795 h	1010 x 510 x 640 h	Ø100
1030 x 630 x 795 h	1010 x 610 x 640 h	Ø100
950 x 710 x 895 h	930 x 690 x 707 h	Ø125
1230 x 830 x 795 h	1210 x 810 x 607 h	Ø125
1330 x 730 x 795 h	1310 x 710 x 607 h	Ø125
1330 x 730 x 895 h	1310 x 710 x 707 h	Ø125
1290 x 800 x 895 h	1270 x 780 x 707 h	Ø125

- Other Dimensions on request

- **Model R-109**

- **Utility**

- Steaming, Dye-works,
Laundry Washing

- **Technical Specification**

- Stainless steel trolley,
non-perforated / perforated,
with-rib, with stainless steel castors



Dimensions

External Dimensions	Internal Dimensions	Castor
1540 x 840 x 880 h	1520 x 820 x 672 h	Ø150
1340 x 740 x 880 h	1320 x 720 x 672 h	Ø150

- Other Dimensions on request



- **Model R-110**
- **Utility**
For Auto Doffing Aluminum basket, feeding empty cops.
- **Technical Specification**
Aluminum basket, non-perforated, without rib, middle sliding bottom and one length side door

Dimensions

External Dimensions

610 x 280 x 600

610 x 250 x 600

- Other Dimensions on request

- **Model R-111**

- **Utility**

Deposit of Fabric in front of weaving machine, measuring and finishing machine Transport and storage of Fabric, Flat-work iron for laundry

- **Technical Specification**

Aluminum trolley, two width side open, without pantograph, non-perforated, without rib, duly anodized and painted, with castors



Dimensions

External Dimensions	Internal Dimensions	Castor
3000 x 1000 x 900 h	3000 x 900 x 692 h	Ø150
2000 x 850 x 1000 h	2000 x 750 x 792 h	Ø150

- Other Dimensions on request



- **Model R-112**

- **Utility**

Deposit of Fabric in front of weaving machine, measuring and finishing machine Transport and storage of Fabric, Flat-work iron for laundry

- **Technical Specification**

Aluminum trolley, two width side open, with-pantograph, Non-perforated, without rib, duly anodized and painted, with castors

Dimensions

External Dimensions	Internal Dimensions	Castor
3000 x 1000 x 900 h	3000 x 900 x 692 h	Ø150
2000 x 850 x 1000 h	2000 x 750 x 792 h	Ø150

- Other Dimensions on request

- **Model R-113**

- **Utility**

Deposit of fabric in front of weaving machine, measuring and finishing machine transport and storage of fabric, flat-work iron for laundry

- **Technical Specification**

Aluminum trolley, two width side open, framing with M.S. pipe, without pantograph, non-perforated, without rib, duly anodized and painted, with castors

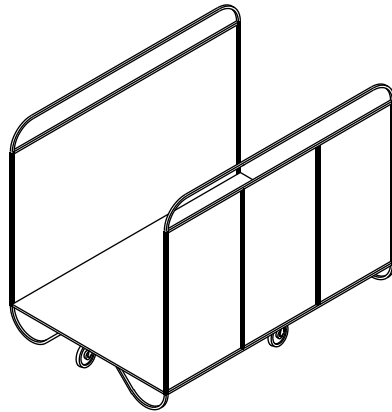

Dimensions

External Dimensions	Internal Dimensions	Castor
1600 x 1060 x 1130 h	1600 x 960 x 942 h	Ø125
3000 x 1000 x 900 h	3000 x 900 x 692 h	Ø150
2000 x 850 x 1000 h	2000 x 750 x 792 h	Ø150

- Other Dimensions on request

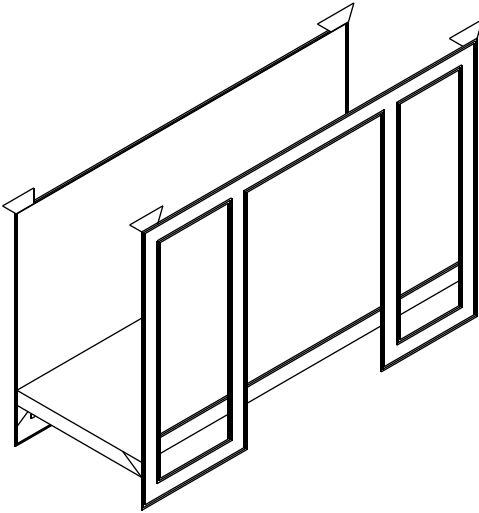

- **Model 114**
- **Utility**
Transport and storage of fabric
- **Technical Specification**
Stackable roll holding containers

Dimensions

External Dimensions	Internal Dimensions	Castor
1600 x 1060 x 1130 h	1600 x 960 x 942 h	Ø125
3000 x 1000 x 900 h	3000 x 900 x 692 h	Ø150
2000 x 850 x 1000 h	2000 x 750 x 792 h	Ø150

- Other Dimensions on request

Trolleys for Flyer-bobbins, Roving-bobbins

- **Model R115**

- **Utility**

Doffing and roving bobbins at the flyer or finisher; withdrawal of empty tubes from the tube compartment for replenishing; transport and intermediate storage of bobbins; direct feeding of the bobbins onto the creel of the ring spinning machine and depositing of the empty tubes into the trolley

- **Technical Specification**

Aluminum flyer bobbins trolley, non-perforated, two width side open, one strong partition, two side shelves for empty bobbins, with castors



Dimensions

External Dimensions	Castor
1350 x 500 x 1410 h	Ø200
950 x 700 x 1100 h	Ø125

- Other Dimensions on request

Trolley Design

Design Note

The choice of model to be used depends mainly on the number of spools per trolley, their sizes and the machine, shelves can be added to hold empty tubes

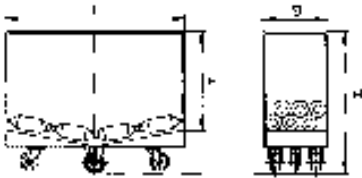

A Middle partition

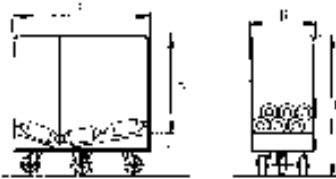

B Onethird partition

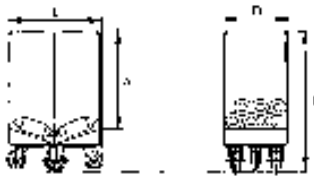

C Middle partitions

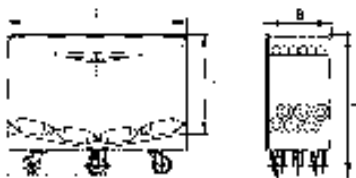

D Middle partition and Two Shelves

- **Model R-116**

- **Utility**

Transport all kinds of bobbins;
steaming, humidifying and
controlling of bobbins

- **Technical specifications**

For quotation: number of bobbins
per trolley; bobbin diameter;
gross weight of a bobbin;
one sample of a tube (or internal
diameter and length of the tube);
if important: maximum
external dimensions of the trolley
(because of elevator steamer);
trolley made of M.S. or
aluminum metal



Trolley Design

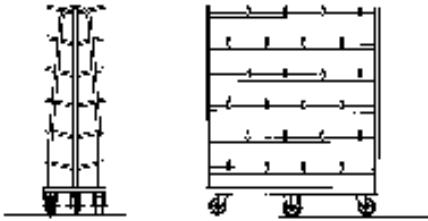

A Loading on two sides

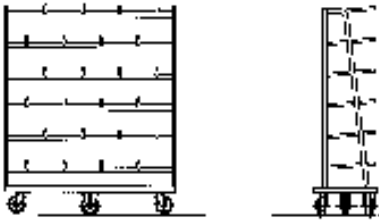

B Loading on one side

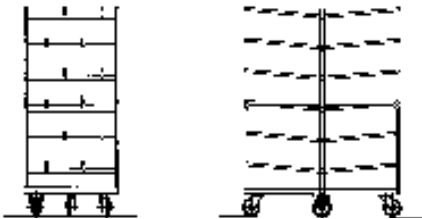

C Loading on two front

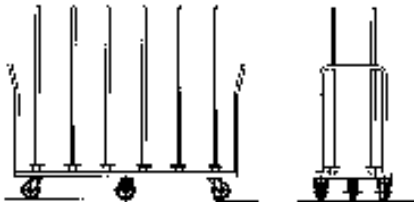

D Vertical Loading

- **Model R-117**

- **Utility**

- Doffing procedure

- **Technical Specification**

- For quotation:
external dimensions of the cops
doffing box at the bottom;
height of the chassis

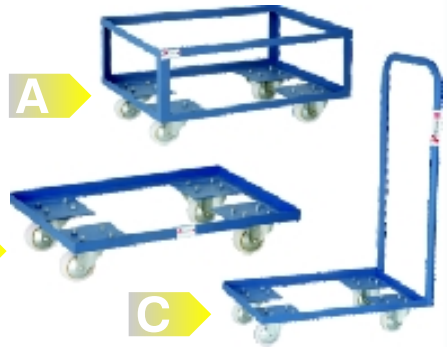



- **Model R-118**
- **Utility**
Transport of all kinds of materials
- **Technical Specification**
Materials Handling trolley, made entirely of coated M.S. section. Laminated plastic. Bottom shelf. One long side completely open. Sides with vertical bars with castors

Dimensions

External Dimensions	Castor
1200 x 700 x 1500 h	Ø 150
1000 x 500 x 1350 h	Ø 150

- Other Dimensions on request

- **Model R-119**

- **Utility**

Covers for Cops Doffing Basket

- **Technical Specification**

Customize as per external dimensions of the cops doffing basket



- **Model R-120**

- **Utility**

Trolley for transportation cops Doffing Basket

- **Technical Specification**

Customize as per external dimensions of the cops doffing basket

- **Ground Clearance as required (castors size)**





- **Model R-121**
Multi functional Trolley
- **Utility**
Use in textile, pharmaceuticals and automobile industries
- **Technical Specification**
HDPE body sheet; non-perforated or perforated; without rib; with castors

Dimensions

External Dimensions	Internal Dimensions	Castor
1030 x 750 x 900 h	1010 x 730 x 712 h	Ø125
820 x 530 x 910 h	800 x 510 x 722 h	Ø100

- Other Dimensions on request

Material Handling Equipment

For the Textiles, Pharmaceuticals and Automobile Industries.
Multi functional Crates

Rimtex crates

- Versatile in use.
- Lightweight.
- Stronger than molded crates.
- Can be stored in stacks.
- Anti-rust.
- Choice of multiple colors.
- Available in custom made sizes.
- Saves on freight.

Body wall

Plain or perforated.

Bottom

Plain or perforated • G.I or Aluminum



External Dimensions

600 x 400 x 320 h

610 x 410 x 375 h

400 x 300 x 320 h

485 x 345 x 405 h

Internal Dimensions

578 x 378 x 297 h

588 x 388 x 352 h

378 x 278 x 297 h

463 x 323 x 382 h

Lets
Promote
Quality

Material Handling Trolley



Rimtex™

MATERIAL HANDLING SYSTEMS



- **Model R-122**
- **Utility**
Material transportation,
linen transportation for laundry
- **Technical Specification**
Bright zinc plated; three shelves;
robust wire formed; with castors

Dimensions

External Dimensions

1150 x 700 x 1500 h

Castor

Ø125

- Other Dimensions on request

Material Handling Trolley

- **Utility**
Material transportation
- **Technical Specification**
Aluminum or stainless steel pipe framing, with castors



Model R-123



Model R-124



Model R-125

Dimensions

External Dimensions

1000 x 600 x 1000 h

900 x 500 x 1000 h

Castor

Ø125

Ø125



- **Model R-126**

- **Utility**

Transport all kinds of materials

- **Technical Specification**

Materials handling trolley, fabricated from M.S. angle and top side covered with anodized aluminum sheet, M.S. pipe duly painted handle on both sides and with castors



- **Model R-127**

- **Utility**

Transport all kinds of materials

- **Technical Specification**

Materials handling trolley, fabricated from M.S. angle and top side covered with anodized aluminum sheet, M.S. pipe duly painted handle one side, with castors

Dimensions

External Dimensions	Castor
1524 x 762 x 965 h	Ø 200
1270 x 660 x 965 h	Ø 200

Full folding wire-mesh boxes and trolleys

Wire mesh boxes total ease in storing and material movement.

Easy for pallet handling.
Easy for multiple stacking.
Easy to store when not in use.



Descriptions

- Bright zinc plated
- Four way forklift access
- Front drop gate for easy access
 - Robust
- Wire formed construction
- Flat folding for space saving in shipping and storage
 - Long lasting; economical
- Alternative to disposable packaging
 - Removable and reusable
 - Castor wheel trolley base



Specifications

MODEL	ETERNAL DIMENSION (mm)			CAPACITY (kgs)	STACKABILITY (LAYER)
	(L)	(W)	(H)		
RWM-01	800	500	550	800	4
RWM-02	800	600	650	800	4
RWM-03	1000	800	850	1200	4
RWM-04	1200	1000	900	1500	4
RWM-05	1400	1200	950	1500	4

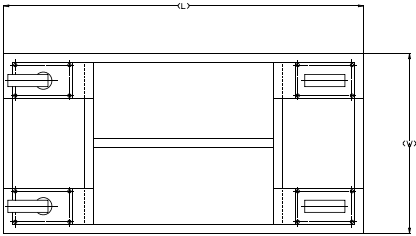
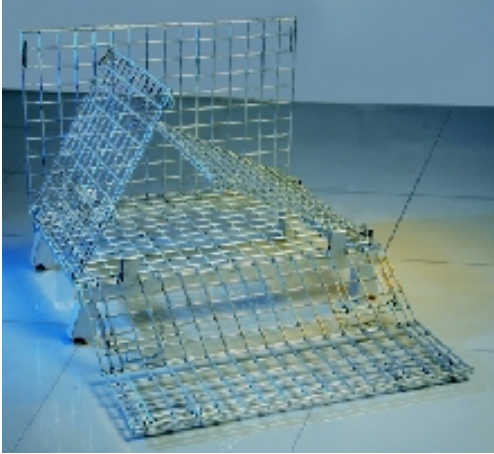

**Removable and reusable
Castor Wheel Trolley Base**

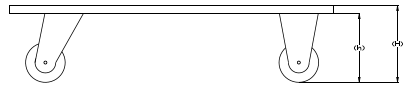

MODEL	ETERNAL DIMENSION (MM)			CASTOR		CAPACITY
	L	W	H	DIAMETER	HEIGHT (h)	
RWM-01T	800	500	190	Ø 125	165	500 KGS
RWM-02T	800	600	190	Ø 125	165	500 KGS
RWM-03T	1000	800	210	Ø 150	185	600 KGS
RWM-04T	1200	1000	210	Ø 150	185	600 KGS
RWM-05T	1400	1200	210	Ø 150	185	600 KGS

MESH (mm)		LEGS HEIGHT (mm)	NET WEIGHT (mm)	VOLUME (CBM)
WIRE GAUGE	MESH SIZE			
6	50 X 50	100	23	0.14
6	50 X 50	100	27	0.22
6	50 X 50	100	45	0.52
6	50 X 50	100	57	0.84
6	50 X 50	100	80	1.25

Other sizes and features available on request

Rimtex Trolley in kit form

Rimtex unassembled Trolley offered in kit form saves on packing and freight cost a great deal. In freight cost of 40 assembled Trolleys it delivers approx 400 unassembled Trolleys.

(It requires unskilled labour to assemble.)



Every care has been taken to ensure the accuracy of this specifications. It was correct at the time of printing but it is for guidance only. In accordance with a policy of continuous development, we reserve the right to change the specification, at any time, without prior notice. The specification for a particular product, the options and details of price and delivery, will be shown in our offer.



Rimtex Industries

1514 GIDC Phase IV
Wadhwan 363 035 Gujarat India

T 00 91 2752 241088 / 243322

F 00 91 2752 243726

E info@rimtex.com