

OVERVIEW



MSS
MARZOLI SUPER SLUB



FANCY YARNS GROWTH & MARZOLI INTEGRATED DEVICE

KEY POINTS

- INTEGRATED FANCY YARN DEVICE
- PATENTED ENGINEERING DESIGN
- ANY FANCY YARN EFFECT AND ALL THEIR POSSIBLE COMBINATIONS

For several years now fancy yarns have been essential components of modern fashion. Their importance has grown consistently as demand for fabrics with distinguishing features has increased and as denim has moved from a basic, simple and durable fabric for work clothing in the '70s and '80s to a fashion fabric with exclusive designs used for all occasions.

The global denim market was valued at \$56,178.1 million in 2017 and is forecasted to witness a CAGR of 5.8% during 2018-2023.

Due to the impressive and consistent expansion of denim, more and more spinners are including fancy yarns in their product range by employing new and more advanced integrated slub devices. Marzoli was the first manufacturer to introduce a fully integrated fancy yarn device on its spinning frames. The close cooperation between Marzoli and some of its customers and an advanced and patented engineering design has produced the most advanced technology for the production of fancy yarns, Marzoli MSS - Marzoli Super Slub.

GLOBAL DENIM MARKET

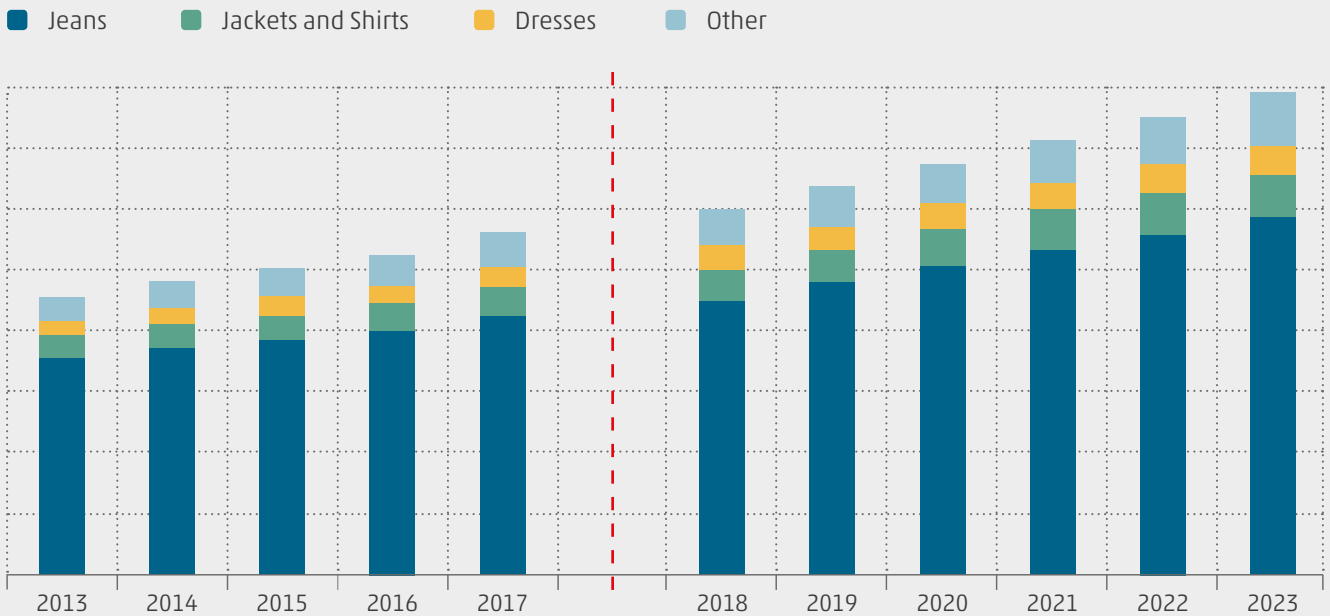

Source: <https://www.psmarketresearch.com/market-analysis/denim-jeans-market>

■ AN UNLIMITED RANGE OF DESIGNS

There are four basic types of fancy yarn: slub, multi-count, multi-twist and reverse slub. Marzoli MSS can produce any of the basic effects and any possible combination for an unlimited range of designs.

The slub effect

With Marzoli MSS, to create a slub is as simple as setting its length in millimeters, its thickness (multiplier) as a percentage of the base yarn and its pause (distance between one slub and the next one) in millimeters. Usually slubs have lengths between 30 and 100 mm, but in some cases slubs are even shorter to produce an effect called "malfile", i.e. small and frequent slubs that create an effect of natural irregularity. Through Marzoli MSS it is possible to produce slubs shorter than 20 mm without compromising yarn quality and strength.

(image 01)

The multi-count effect

The multi-count effect is obtained through prolonged variations of the main draft. The result is a yarn that has different counts but constant twist.

(image 02)



The multi-twist effect

The multi-twist effect does not entail count variations in the yarn: it only entails twist variations. The twist differential changes the yarn diameter and this creates attractive color shades in the yarn and consequently on the fabric.

(image 03)

Multicount & Multitwist combination

Usually the multicount and the multitwist effects are used together as their combination entails very interesting effects on the fabric. For each count a different desired twist, based on a selected constant " α ", is applied.

The reverse slub effect

Reverse slub is obtained through continuous variations of the main draft that, unlike the slub effect, are negative and reduce the yarn thickness.



image 01



image 02



image 03

MARZOLI MSS

Marzoli was the first textile machinery manufacturer to design and launch an integrated slub device which requires no mechanical modification nor mechanical attachment to the spinning frame.

Since its launch, in 1999, Marzoli integrated slub device has been the world leader among integrated slubbing devices. Its market success (over 300,000 spindles) has been due to:

- Great flexibility. It can produce any fancy yarn effect and all their possible combinations.
- Quality of the yarn. It does not create any weak point on the yarn thanks to special and independently settable acceleration and deceleration curves.

Features of Marzoli integrated application

- Fully integrated system;
- User-friendly and simple HMI, with values in mm and percentages;
- Motors acceleration and deceleration ramps up to 10 ms, with sinusoidal shapes to produce yarn without weak points;

KEY POINTS

- LOW INERTIA DRAFTING SYSTEM DRIVE
- FULL CONTROL OF ACCELERATION AND DECELERATION OF THE DRAFTING ROLLERS AT HIGH SPEED
- Automatic visualization of the graph related to the slub recipe under production in order to check the right execution;
- Automatic control of the slubs features during editing with warning in case of not workable parameters;
- Slub formation without changing the front roller speed, for a perfect distribution of the twist on the yarn;
- Up to 500 lines for 500 different slubs in a single recipe;
- Automatic generation of the recipes by inserting only the minimum and maximum values for each parameter;
- Reading choices: "random", "cycle" and "Mcch";
- Up to 10,000 different recipes saved in the machine;
- Connection to YarNet for the editing of slub recipes on a remote PC;
- "Draw your slub" (option): possibility to draw the shape of the slub on the panel.

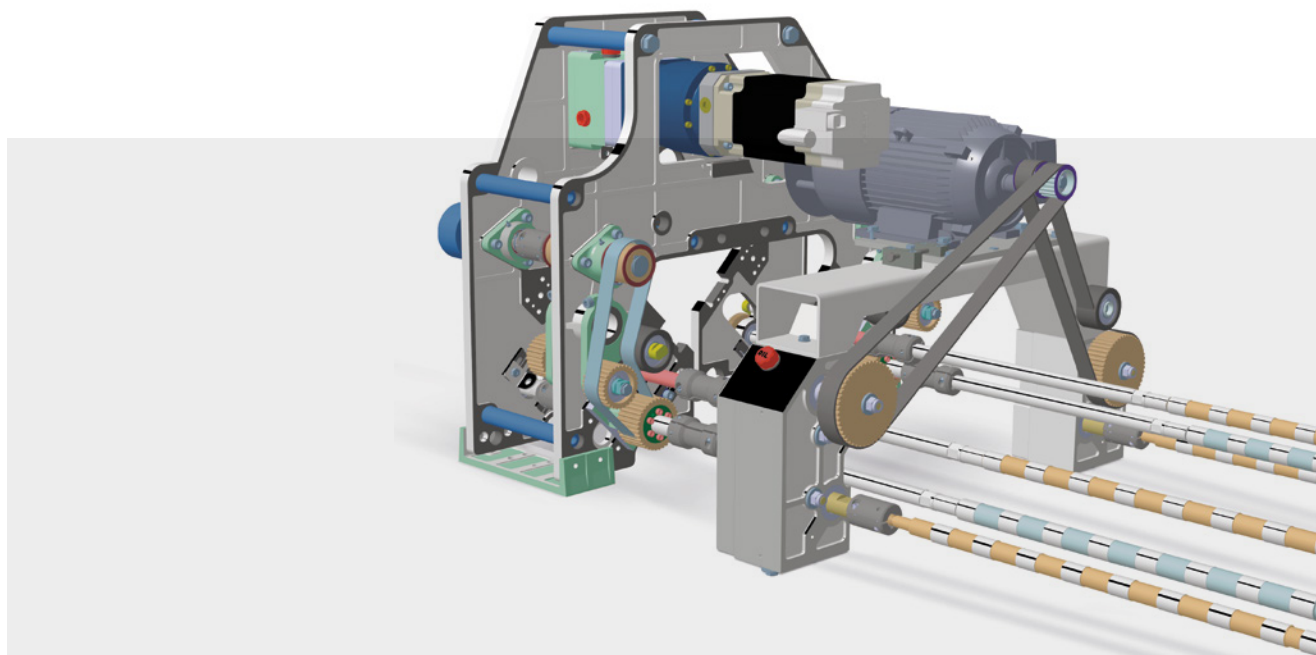

■ MSS – MARZOLI SUPER SLUB

The MSS is Marzoli leading technology designed to obtain the highest performance on quality and speed in the production of slub yarn.

It is the combination of a patented drafting system drive, installed on Marzoli MDS2, the purposely designed software with independently settable and special acceleration and deceleration ramps and high-performance electronics.

With reference to the drafting system drive, only a very low inertia driving unit ensures steeper and fully-controlled acceleration and deceleration ramps. Existing technologies are using either a heavy gearbox or low inertia epicyclic gearbox driven by a motor through pulleys and belts.

Both systems have high inertia and can not perform fast and controlled acceleration and deceleration in high speed production.

The images show the difference between conventional systems and Marzoli MSS.

The cinematic scheme of Marzoli MSS, motor-epicyclic gearbox - timing belts - bottom rollers, allows to reduce the inertia of all the rotating parts after the gearbox around 1000 times.

This technology enables customers to have no limitation in the shape of the slub and have full control on acceleration and deceleration of the drafting rollers at high production speed.

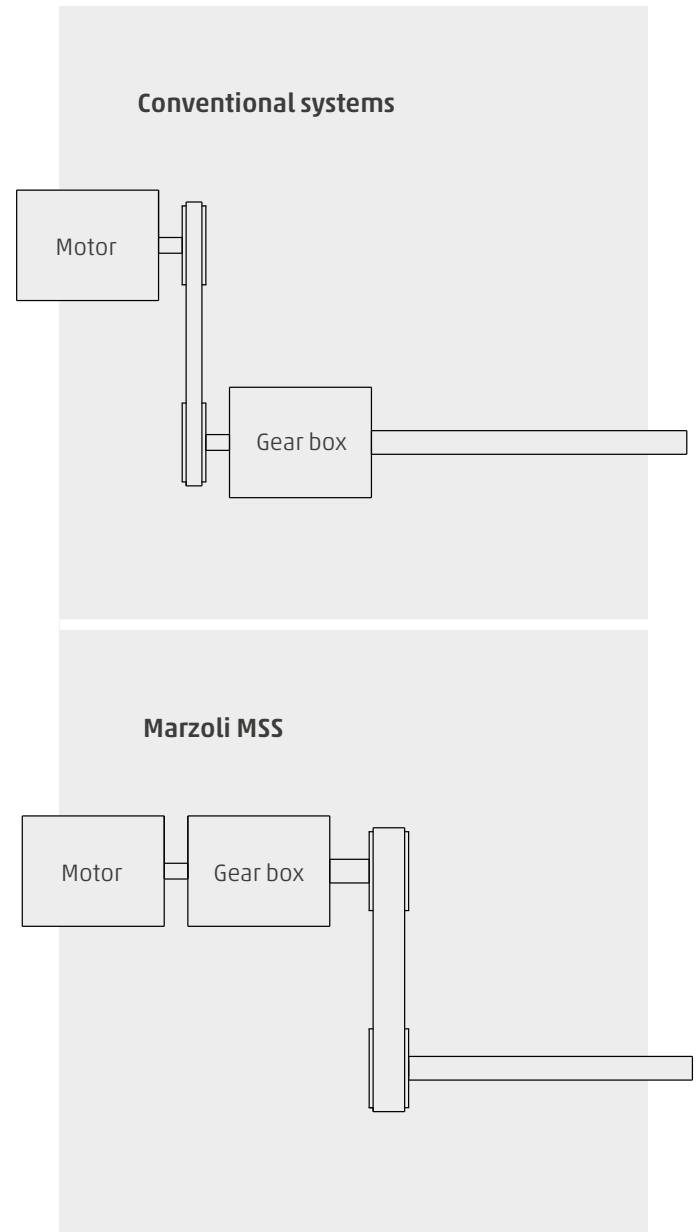

NO THIN OR WEAK POINTS

One of the main challenges in the production of fancy yarns is to avoid the formation of thin and weak points at the end of the slub. Thin and weak points enhance the number of yarn breakages during weaving operations and thus increase the number of defects on the fabric and reduce the efficiency of the machines. With Marzoli MSS, thin and weak points are avoided. Acceleration and deceleration ramps are settable independently. It is possible to insert a steep acceleration curve and then decelerate in a gentle manner. At the end of the acceleration and deceleration ramp there are special Marzoli curves to approach the final speed in a more controlled manner.

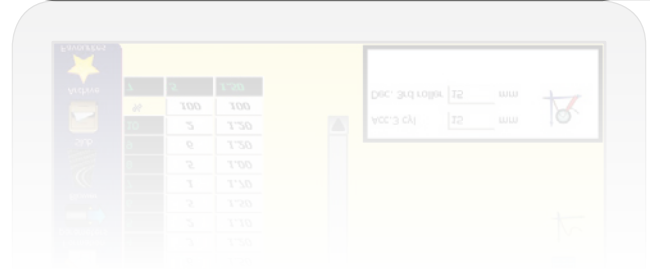
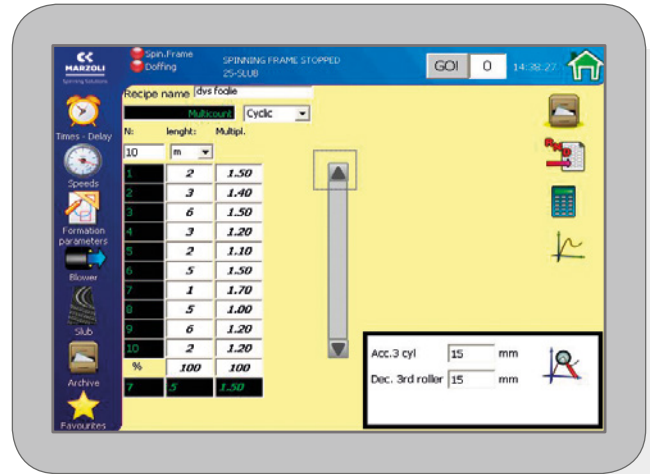

Normal curve

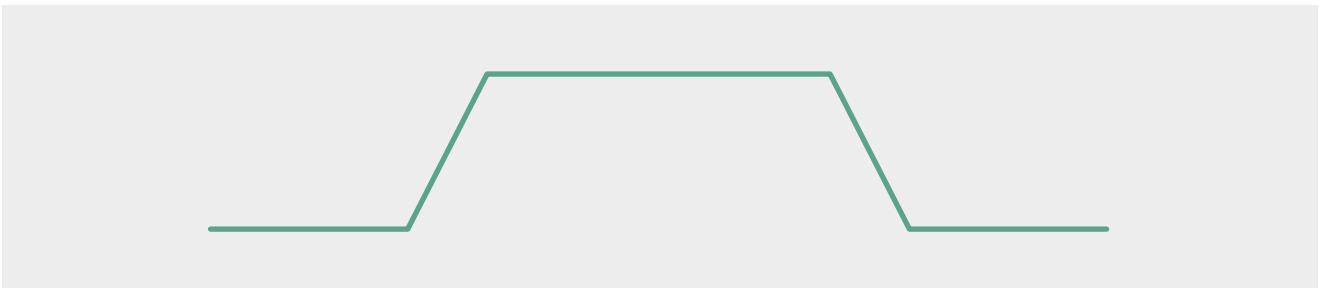

Marzoli's curve

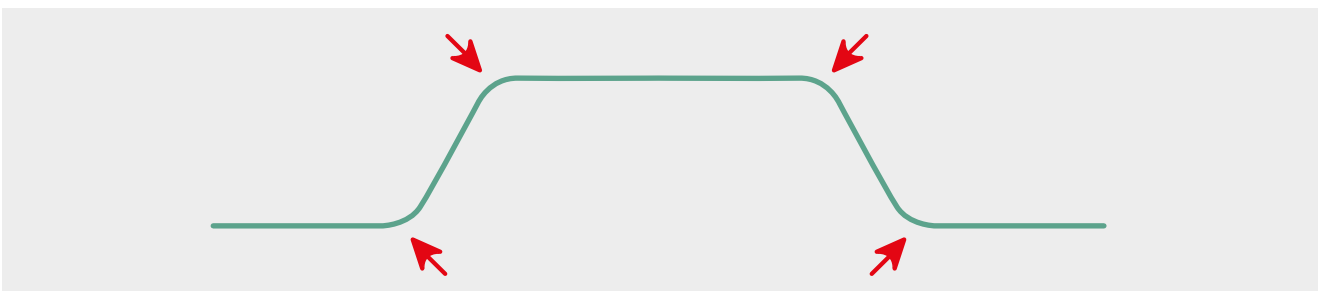

HIGHEST PERFORMANCES ON SLUB YARNS

The purposely designed and user-friendly software and the patented low-inertia drive for the drafting system, allow to obtain:

- effects that are not achievable with competitor machines;
- to obtain the same effects of competitor machines with higher production speeds;
- no thin points at the end of the slub thanks to a better control of the acceleration and deceleration of the drafting rollers.

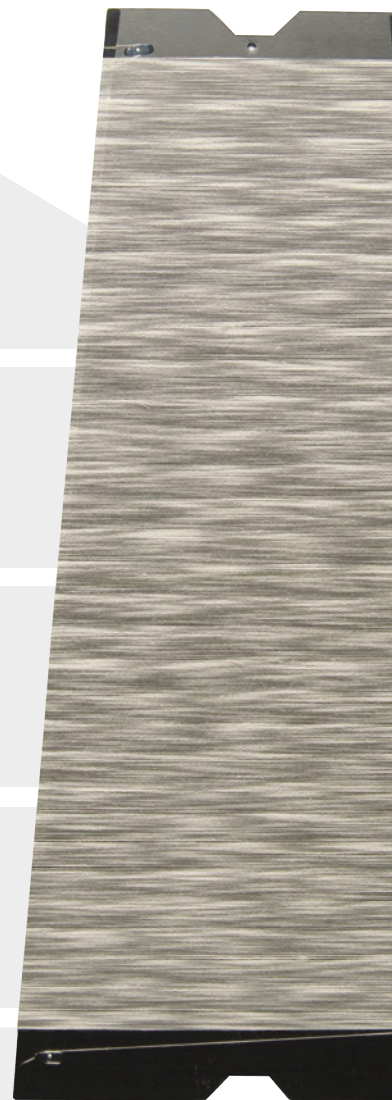
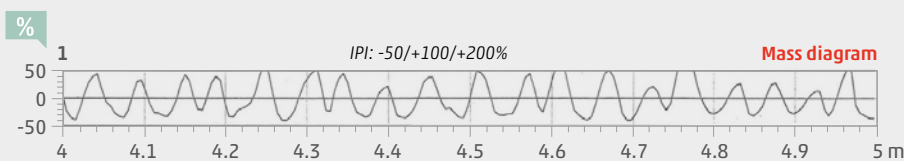
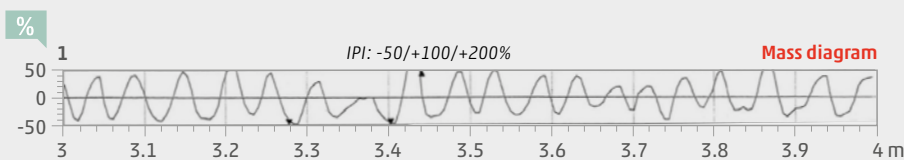
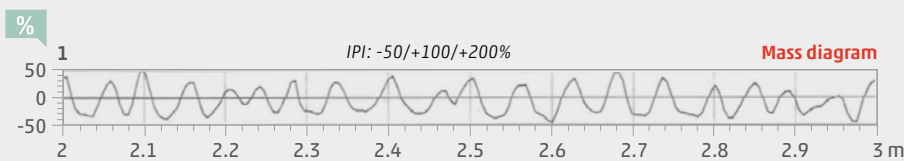
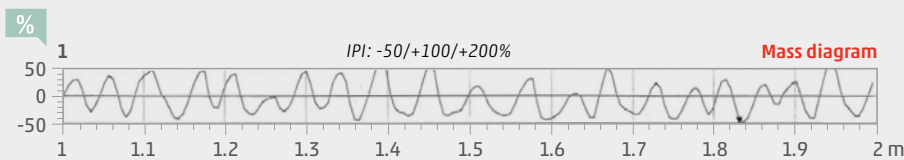
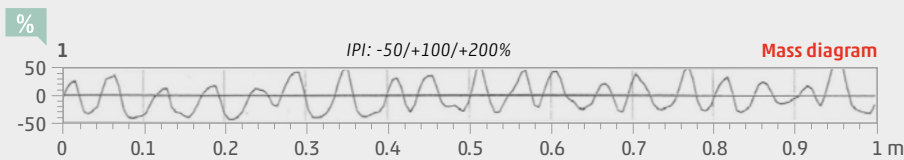
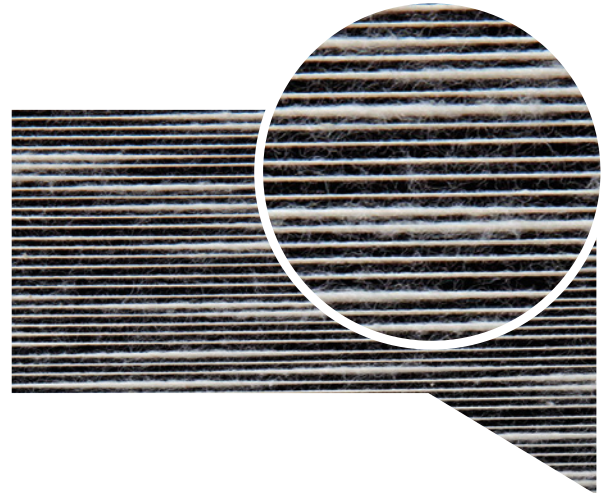

USER-FRIENDLY INTERFACE

One of the distinguishing characteristics of Marzoli MSS is its ease of use and simple settings.

By using a touch screen, users can quickly enter all data needed to create any fancy yarn recipe.

Slub recipes can also be easily transferred through YarNet from one machine to another.

The operator edits the slub recipe on a remote PC and send it to any machine he wants.

SLUB COMBINATIONS

- S (Slub)
- MC (Multicount)
- MT (Multitwist)
- MC + MT
- MC + S
- MT + S
- MC + MT + S
- RS (Reverse slub)
- RS + MC
- RS + MT
- RS + MC + MT
- SOS + MC
- SOS + MT
- SOS + MC + MT

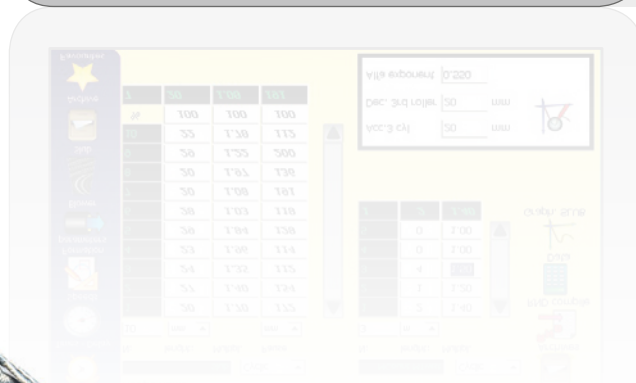
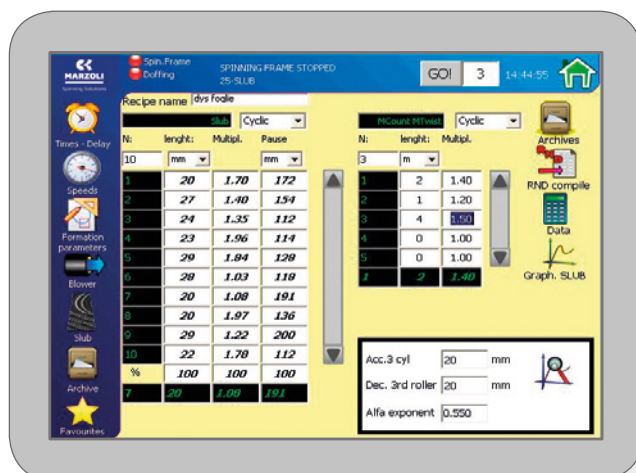
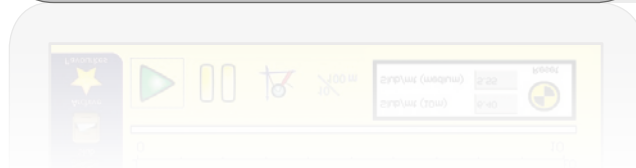
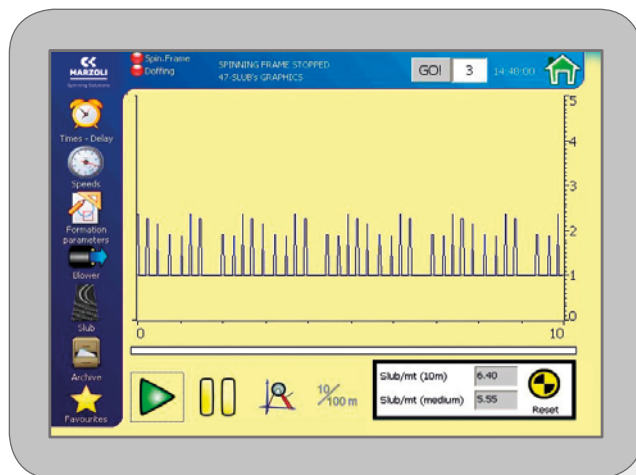

DRAW YOUR SLUB

The patented system to edit fancy yarn recipes

With the innovative and patented application "Draw your Slub", the slub is drawn in a dedicated editor.

The editor is very simple to use: by making a double click on the panel, the operator creates single points that are then connected with lines.

The line shows the trend of the multiplier, i.e. the diameter of the slub (y) as a function of the length of the slub (x).

Once the editing is over, the operator gives an identification number to the slub.

Then, the operator recalls the identification number in the slub table and inserts the length and the pause of the slub.

This system gives spinners enormous advantages: the most important one is that all kinds of slub drawings and shapes are achievable.

In traditional systems (competitors) the slub can only have one constant diameter according to the set multiplier, while with Marzoli system the diameter may vary infinite times on every single slub. Moreover, in traditional systems the acceleration and deceleration ramps, that influence the visual effect of the yarn, are pre-setted. With Marzoli system acceleration and deceleration ramps are completely settable, also for every single slub.

An additional advantage is that with this system spinners may gradually change the count on long portions of yarn: they may create "incremental multicount" with a single and simple drawing inserting only the desired length. With the "old" system hundreds of program lines were required.

KEY POINTS

- EASY EDITING OF SLUBS
- FAST DESIGN OF ANY TYPE OF SLUB

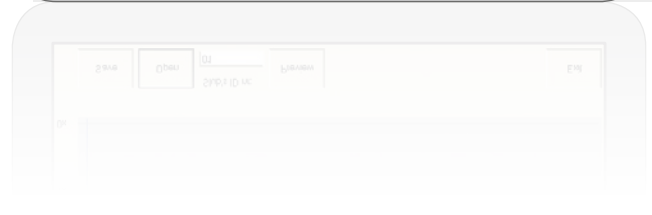
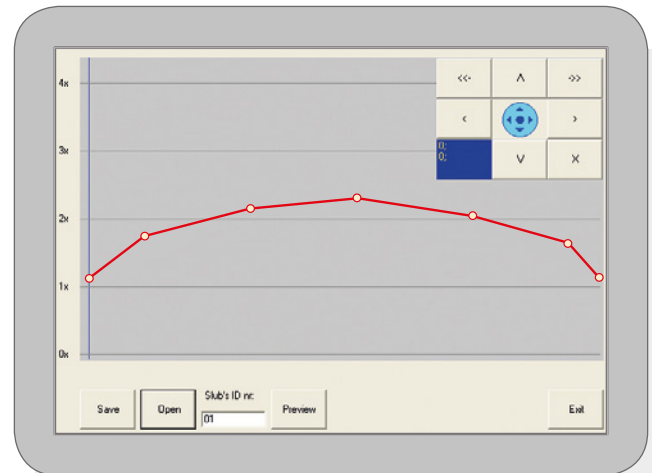

Example of drawn slub

Through the editor we create a slub with a saw tooth shape. We give to this drawing the identification number "5".

We close the editor and we go back to the slub table. In the slub table we create a slub (Slub 1): we recall the slub shape identified with number 5 (ID#), we set 200 mm as slub length and 400 mm as pause length. Then, we create a second slub (Slub 2): we recall the slub shape identified with number 5 (ID#), we set 100 mm as slub length and 150 mm as pause length.

Slub 1 and 2 have the same shape (saw tooth) but different lengths, the first one 200 mm, the second one 100 mm.

This is because at the slub drawing identified with number 5 have been applied two different lengths (line 1 and 2).

It is possible to eliminate the pause in order to obtain a completely drawn yarn: it is sufficient to set 0 mm as pause length.

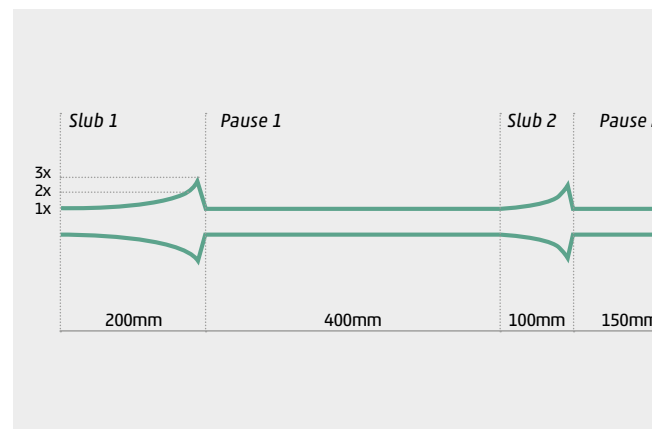
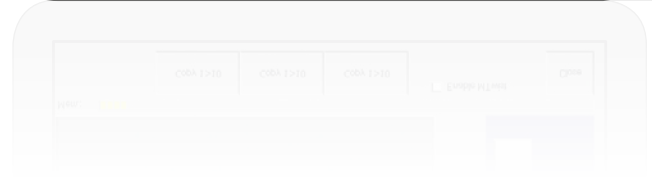
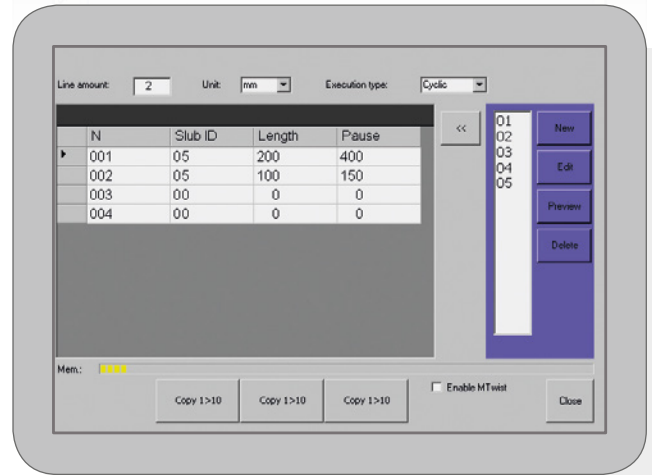
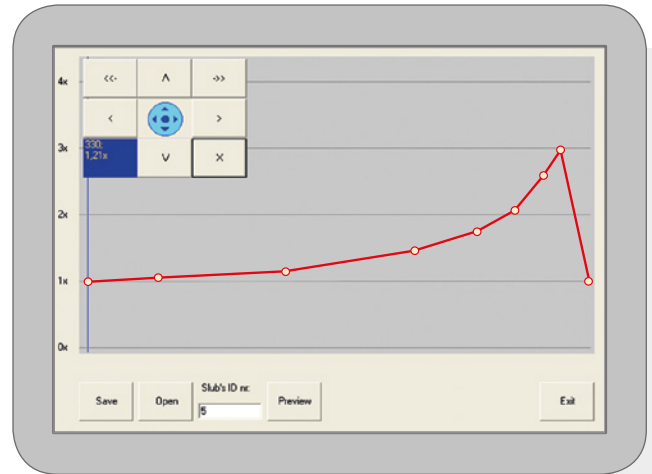

SOFTWARE PLATFORMS

END2END PRODUCTION MANAGEMENT PLATFORM: YARNET

YarNet is Marzoli production management software. It enables the monitoring of production levels, efficiency rates and downtime for both individual machines and the entire spinning mill. Comparisons between machines on selected periods of time are made very simple so that improvement opportunities can be easily identified. YarNet enables the operator to edit production recipes, downloading and uploading them between any machine and their computer. He can also export them in Excel format to share with colleagues as necessary. YarNet gathers and analyses data about production and energy consumption, giving a visual representation of the tradeoffs (kW/kg).

MRM

MRM is Marzoli software to continuously monitor the operating conditions of textile machines. It can identify developing malfunctions before a fault occurs and highlight improvement opportunities on efficiency rates and energy consumption levels. Data about temperature, power consumption, speed and vibration are collected from PLCs (programmable logic controllers) and sensors installed on each machine. The software verifies the monitored parameters are within the nominal operating ranges; it can even adjust for room temperature variations to ensure continuous optimisation. If any parameter is out of tolerance, an automatic email alert is sent to the customer. The customer can also access the dedicated online portal to see information for predictive maintenance and of the overall efficiency of the plant. Through dedicated modules (Optimisation Tools) it is possible to optimise the performance of every machine, in particular on energy consumption and levels of efficiency. If required, Marzoli's customer service team can access the data to diagnose actual and developing problems and recommend appropriate actions.

KEY POINTS

- EASY & FAST CONTROL OF EVERY STAGE OF THE SPINNING PROCESS
- IMPROVED SPEED OF RESPONSE IN PRODUCTION OPERATIONS
- EASY MANAGEMENT OF PRODUCTION RECIPES
- SUPERIOR, EASIER AND FASTER MAINTENANCE

YARNET

Marzoli Production Management

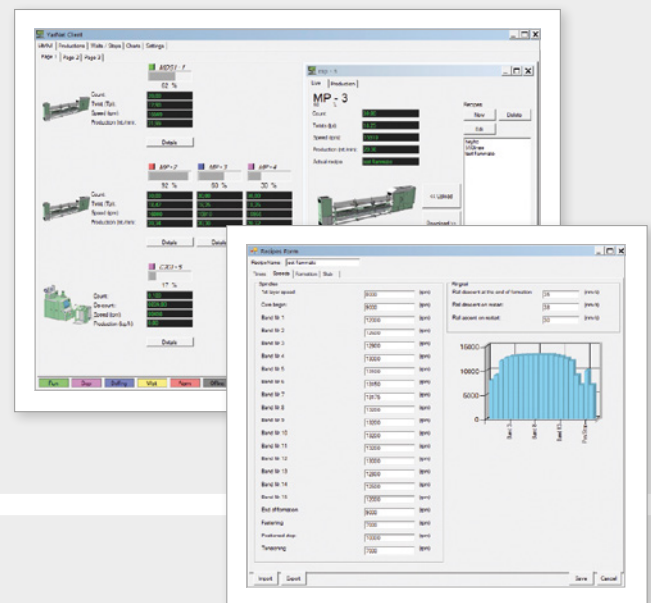

MRM Marzoli Remote Maintenance

IoT Platform by Microsoft®

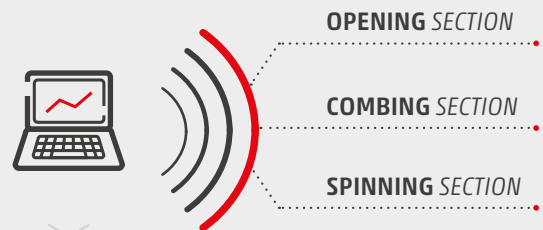

BENEFITS

- Higher productivity
- No machines unplanned downtimes
- Prevention from major machine failures
- Longer plant lifespan
- Higher efficiency
- Complete reliability
- Trouble free spinning experience
- Better maintenance planning

MARZOLI
INTERNATIONAL, INC.
USA

MARZOLI MACHINES
TEXTILE SRL
Italy

MARZOLI INDIA
MTMM PVT. LTD.
India

- Legend**
- Marzoli premises
 - Sales & service network
 - Sales affiliates

Marzoli Machines Textile S.r.l.
Via Sant'Alberto, 10
25036 Palazzolo sull'Oglio (BS)
Italy
Tel. +39 030 73091
sales@marzoli.it

Marzoli International, Inc.
100 Corporate Dr., Suite M
Spartanburg, SC 29303
U.S.A.
Tel. +1 864 599 7100
Fax +1 864 599 7111
sales@marzoli.com

**Marzoli India
MTMM Pvt. Ltd.**
Shed No 6, Bangalore Main Road
SIDCO Industrial Estate
Hosur - 635 126
Krishnagiri District, Tamil Nadu
India
Tel +91 4344 400111

MARZOLI
Textile Engineering

A Camozzi Group Company
www.marzoli.com

